

Pauschalisierte Wohnflächenberechnung inkl. Grundrisserstellung

Straße HNr. Hofberg 69	PLZ Ort 84489 Burghausen , Salzach
Objekt Mehrfamilienhaus ab 3 Mietern	Zusatz



Auftraggeber McMakler	Auftrag durchgeführt am 28.02.2020 um 14:33 Uhr
Darlehensnehmer	Auftrag durchgeführt von [REDACTED]
Kunden-/Vertrags-Nr.	Auftragsnummer [REDACTED]

Auftragsoption Pauschalisierte Wohnflächenberechnung	✓
Auftragsoption Grundrisserstellung	✓

Kolbermoor
28.02.2020

Ort und Datum

[Redacted]

Name Besichtiger

[Redacted]

Unterschrift Besichtiger

Pauschalisierte Berechnung der Wohnfläche

Aufbau	Nr.	Nutzung / Lage	Art	Länge	Breite	Fläche	Wohn- / Gewerbefläche
EG							
keine	1	Wohnen	W	4,17 m	3,31 m	13,80 m ² x m	13,80 m ²
	2	Wohnen	W	3,75 m	2,76 m	10,35 m ² x m	10,35 m ²
	3	Küche	W	2,80 m	1,29 m	3,61 m ² x m	3,61 m ²
	4	Bad	W	2,80 m	1,80 m	5,04 m ² x m	5,04 m ²
						Wohnen:	32,80 m²
						Gewerbe:	0,00 m²
1. OG							
keine	1	Wohnen	W	8,15 m	3,60 m	29,34 m ² x m	29,34 m ²
	2	Schlafzimmer	W	3,89 m	2,90 m	11,28 m ² x m	11,28 m ²
	3	Bad	W	2,50 m	2,00 m	5,00 m ² x m	5,00 m ²
	4	Bad	W	1,00 m	0,90 m	0,90 m ² x m/-1	-0,90 m ²
	5	Gang	W	1,30 m	0,90 m	1,17 m ² x m	1,17 m ²
	6	Küche	W	4,50 m	2,60 m	11,70 m ² x m	11,70 m ²
	7	Terrasse	W	5,50 m	2,60 m	14,30 m ² x m/2	7,15 m ²
						Wohnen:	64,74 m²
						Gewerbe:	0,00 m²
DG,							
keine	1	Küche	W	3,11 m	2,60 m	8,09 m ² x m	8,09 m ²
	2	Bad	W	3,02 m	2,48 m	7,49 m ² x m	7,49 m ²
	3	Wohnen	W	4,70 m	3,10 m	14,57 m ² x m	14,57 m ²
	4	Wohnen	W	5,50 m	3,80 m	20,90 m ² x m	20,90 m ²
	5	Terrasse	W	2,00 m	2,00 m	4,00 m ² x m/2	2,00 m ²
	6	Zimmer 1	W	4,50 m	3,00 m	13,50 m ² x m	13,50 m ²

7 Zimmer 2 W m x m = m² x m m²

Wohnen: 79,15 m²

Gewerbe: 0,00 m²

Gesamt Wohnen: 176,69 m²

Gesamt Gewerbe: 0,00 m²

Raumteile mit einer Höhe von weniger als 1 Meter: keine Anrechnung,

Raumteile mit einer Höhe über 1 Meter, aber unter 2 Metern: 50-prozentige Anrechnung

Raumteile mit einer Höhe über 2 Metern: volle Anrechnung auf die Wohnfläche

Terrasse/Balkon/Wintergarten: Anrechnung zur Hälfte, aber Deckelung bei 15% der reinen Wohnfläche

Statistiken

Bodenfläche: 237 m²

3 Stockwerke

1 Schlafzimmer

3 Badezimmer

Erdgeschoss

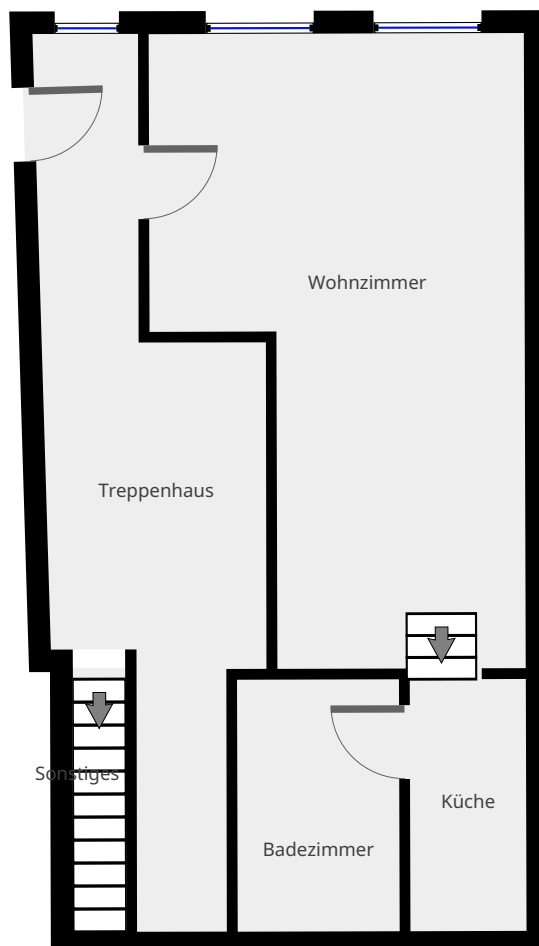

Küche

Breite 1.29 m
Länge: 2.80 m
Bodenfläche 3.61 m²
Umfang: 8.18 m

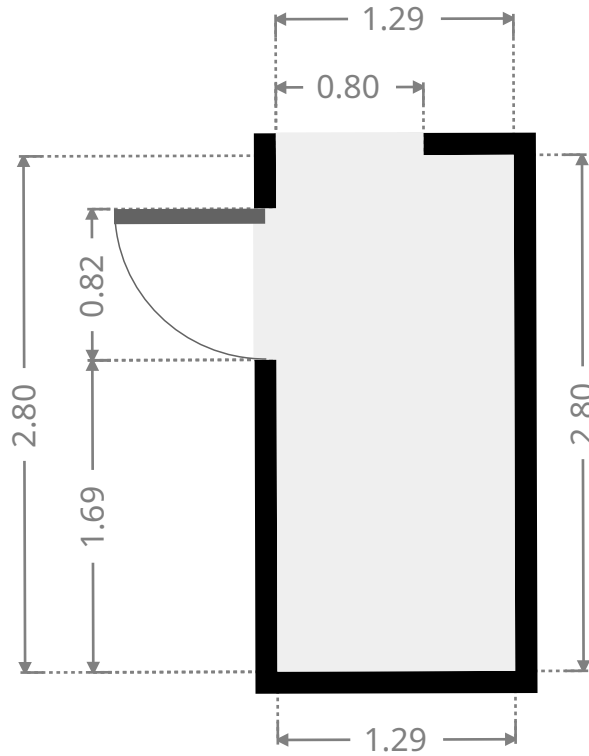
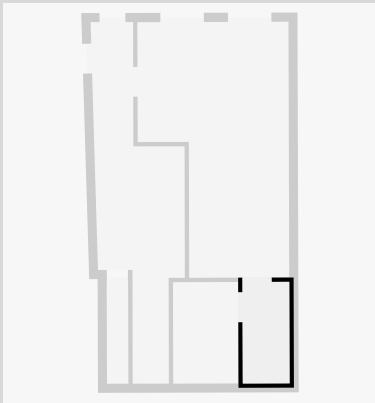

Badezimmer

Breite 1.80 m
Länge: 2.80 m
Bodenfläche 5.04 m²
Umfang: 9.20 m

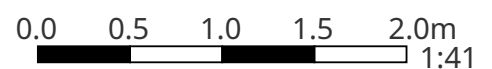
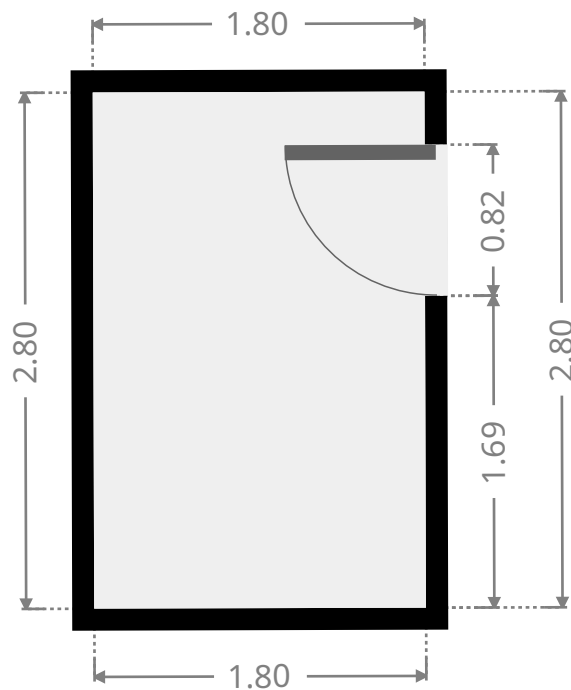
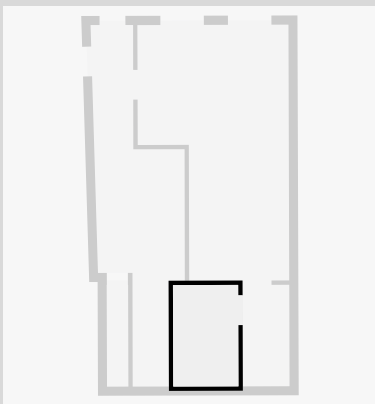

Wohnzimmer

Breite 4.17 m
Länge: 7.06 m
Bodenfläche 24.15 m²
Umfang: 22.46 m

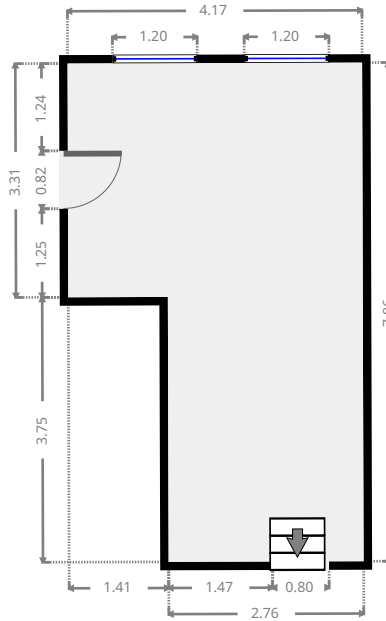
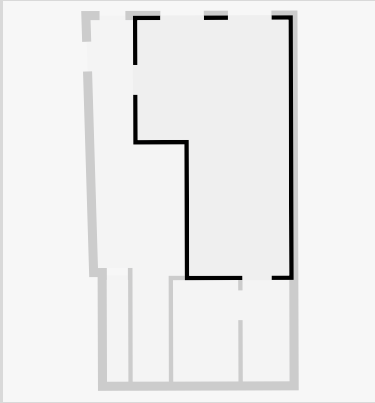

Treppenhaus

Breite 2.59 m
Länge: 9.98 m
Bodenfläche 15.43 m²
Umfang: 24.95 m

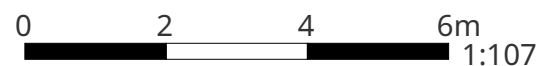
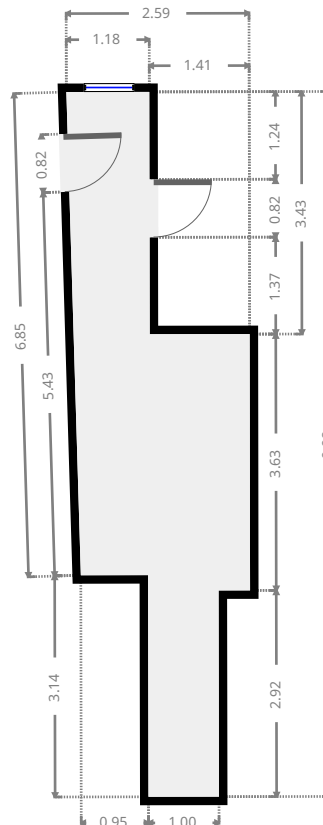
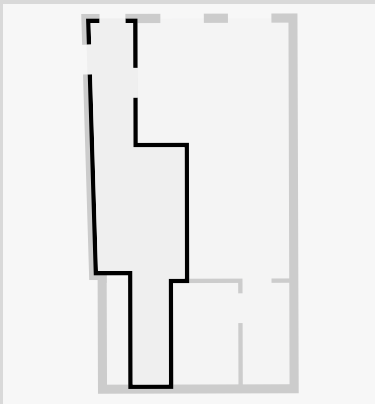



Sonstiges

Breite 0.59 m
Länge: 2.81 m
Bodenfläche 1.66 m²
Umfang: 6.80 m

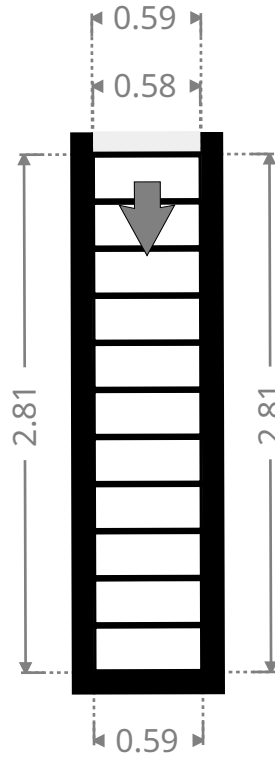
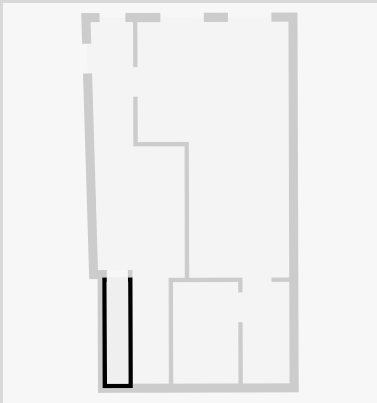

Statistiken

Bodenfläche: 237 m²

3 Stockwerke

1 Schlafzimmer

3 Badezimmer

1. Stock

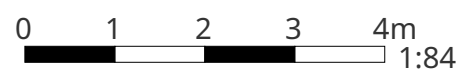
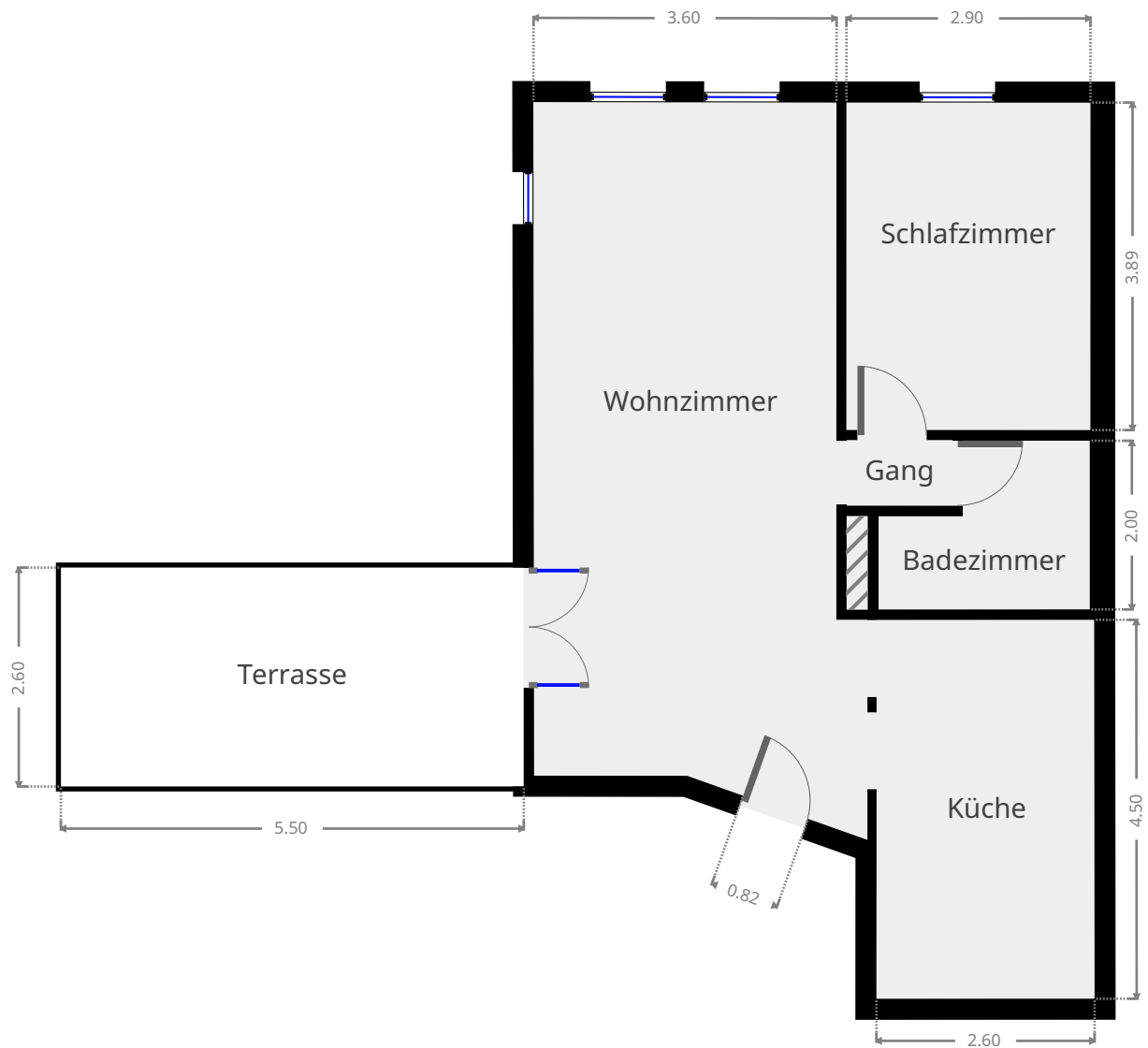

Schlafzimmer

Breite 2.90 m
Länge: 3.89 m
Bodenfläche 11.28 m²
Umfang: 13.58 m

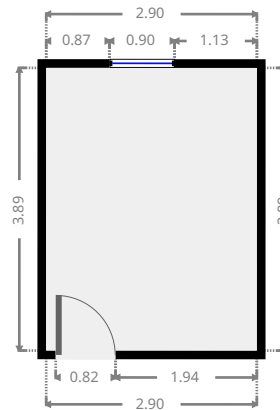
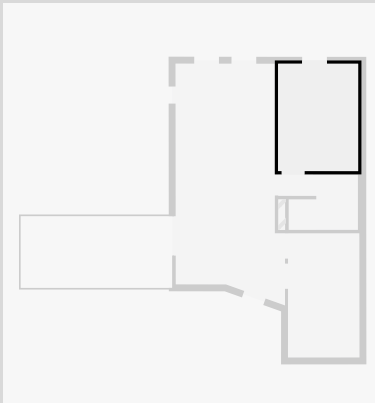

Wohnzimmer

Breite 3.97 m
Länge: 8.76 m
Bodenfläche 30.27 m²
Umfang: 24.82 m

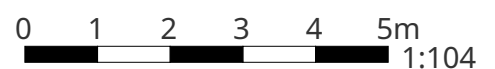
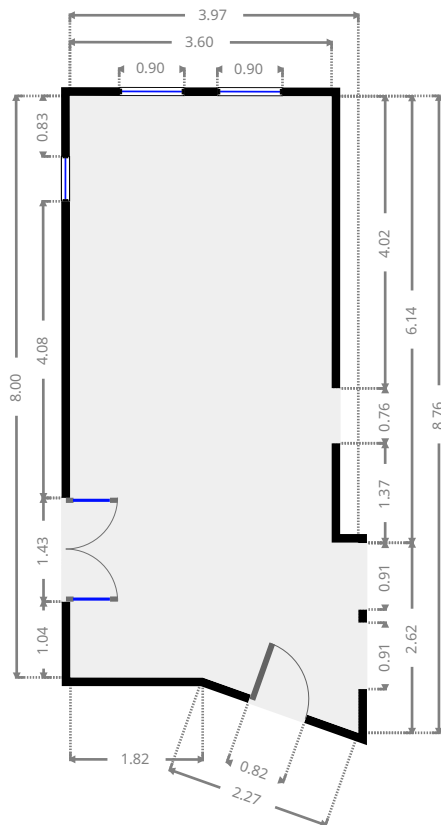
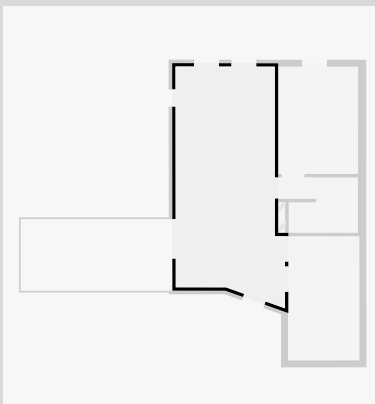



Badezimmer

Breite 2.00 m
Länge: 2.51 m
Bodenfläche 4.13 m²
Umfang: 9.03 m

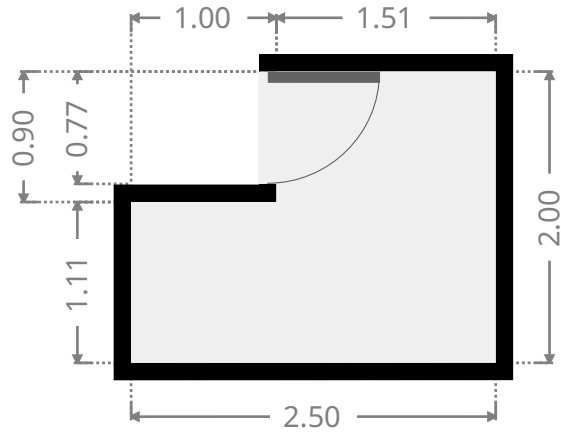
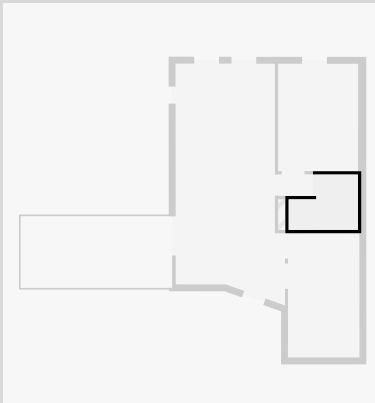

Küche

Breite 2.59 m
Länge: 4.50 m
Bodenfläche 11.64 m²
Umfang: 14.18 m

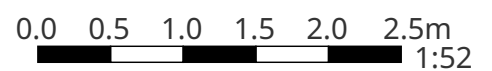
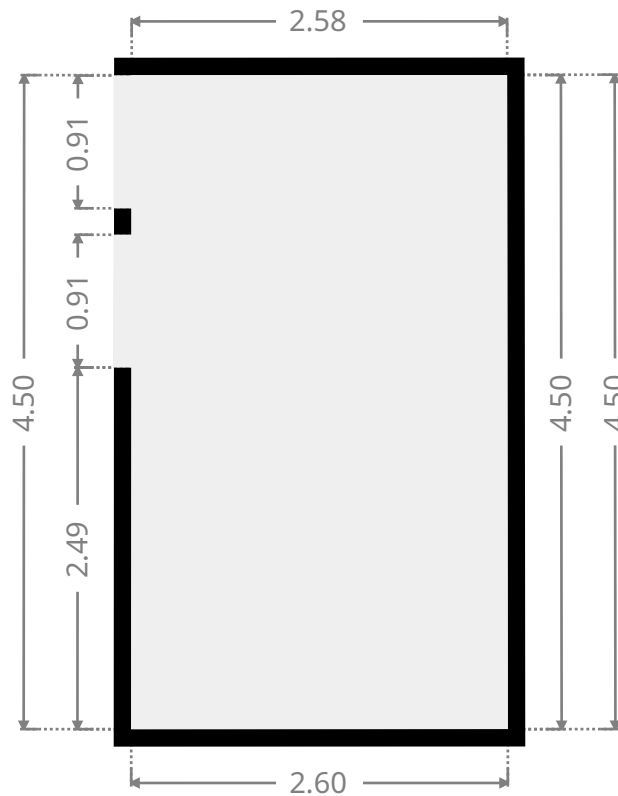
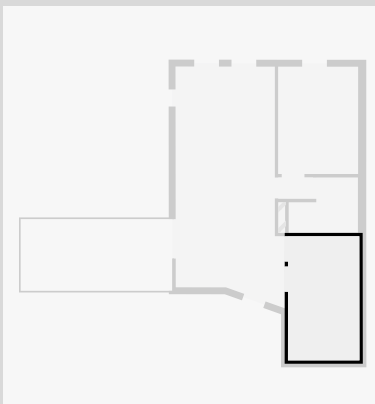



Gang

Breite 0.78 m
Länge: 1.26 m
Bodenfläche 0.98 m²
Umfang: 4.08 m

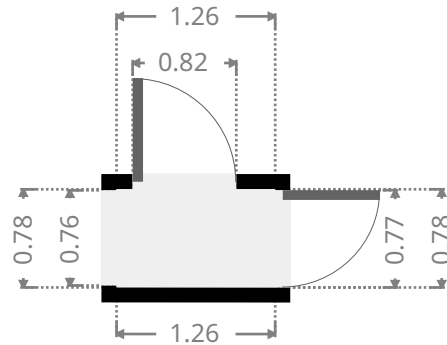
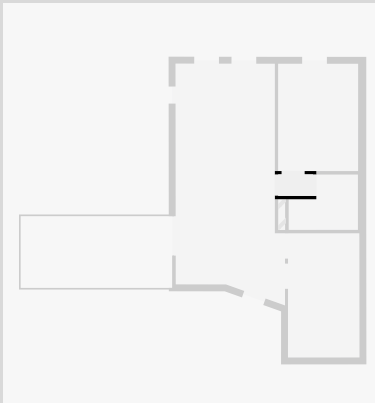

Terrasse

Breite 2.60 m
Länge: 5.50 m
Bodenfläche 14.30 m²
Umfang: 16.20 m

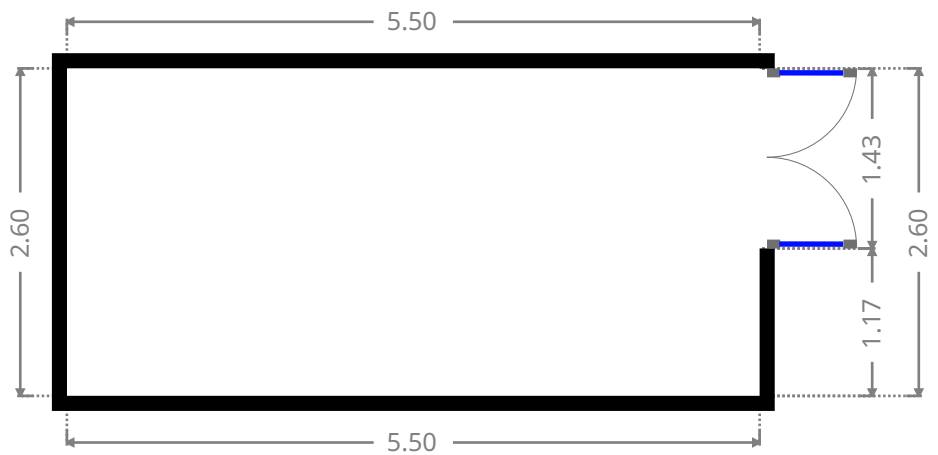
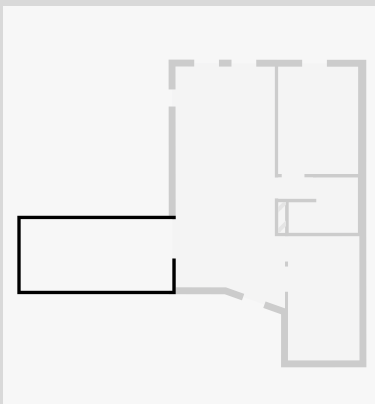

Statistiken

Bodenfläche: 237 m²

3 Stockwerke

1 Schlafzimmer

3 Badezimmer

Dach

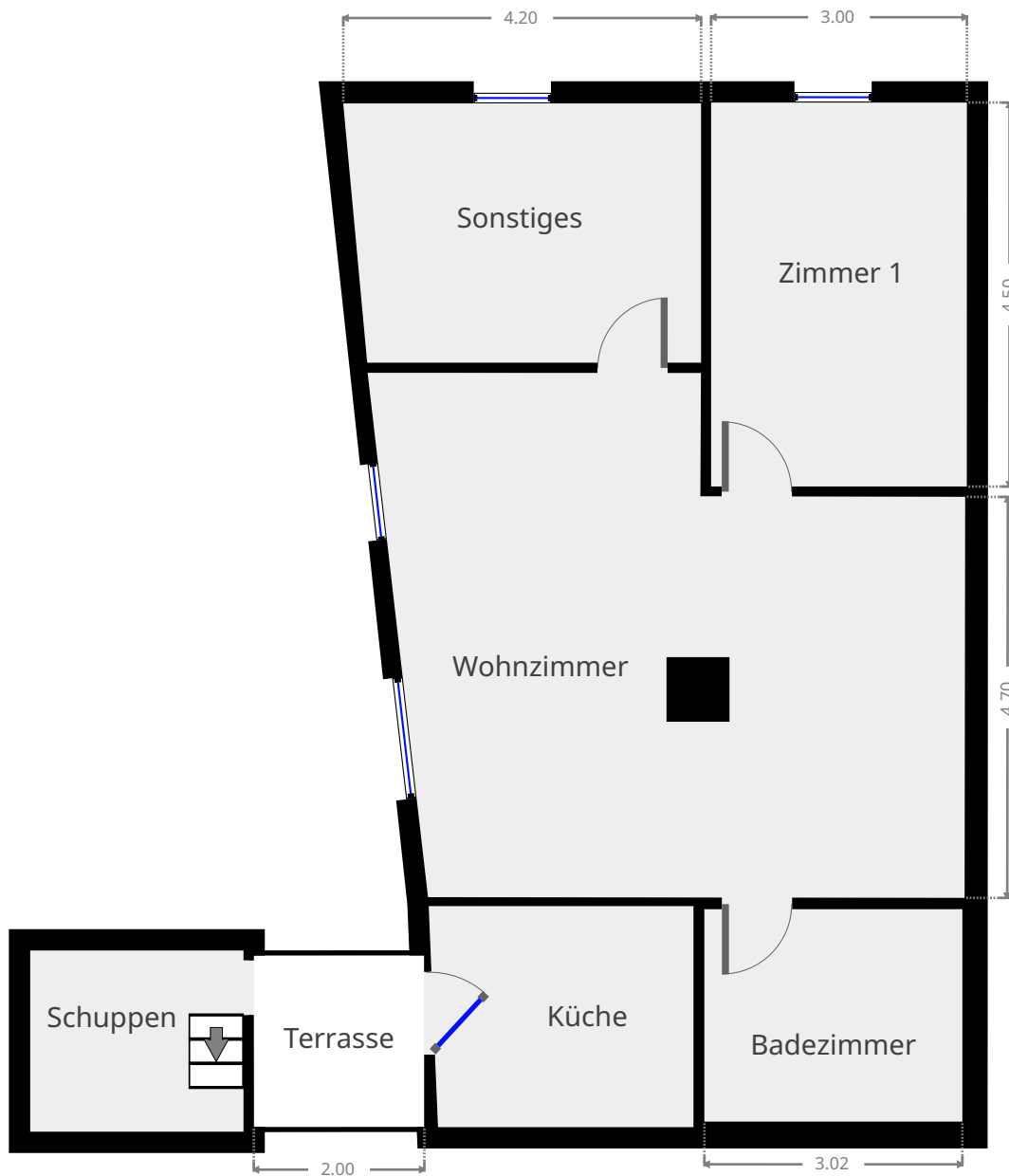



Badezimmer

Breite 2.49 m
Länge: 3.02 m
Bodenfläche 7.53 m²
Umfang: 11.03 m

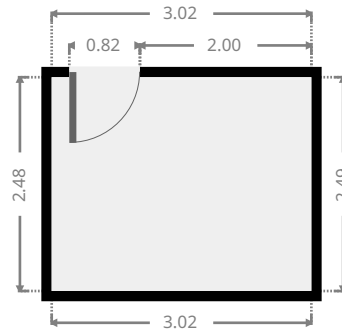
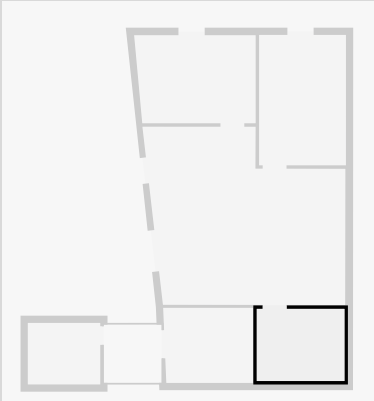

Wohnzimmer

Breite 6.15 m
Länge: 7.01 m
Bodenfläche 36.37 m²
Umfang: 25.63 m

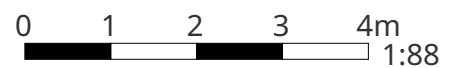
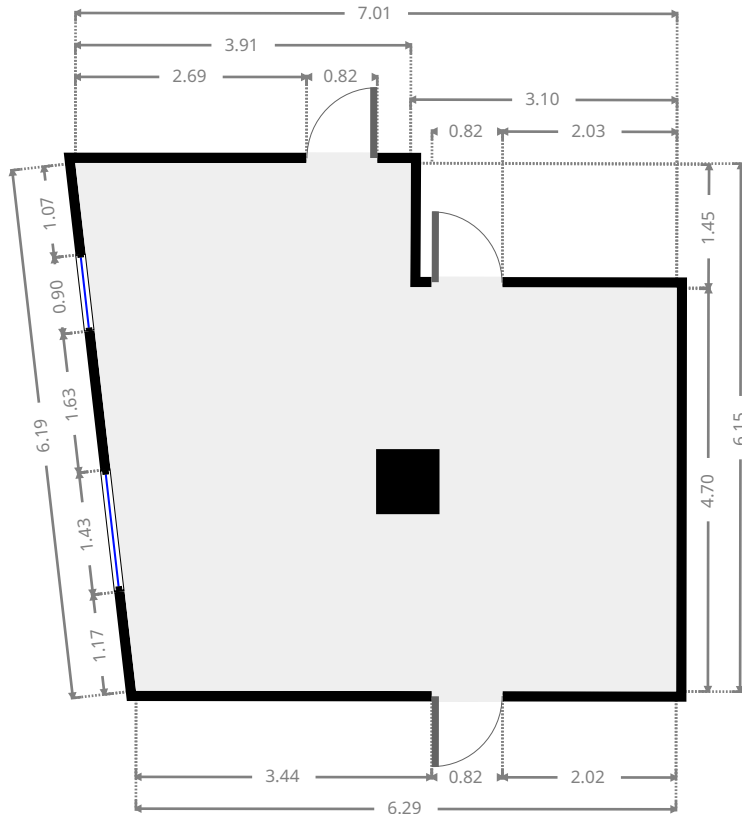
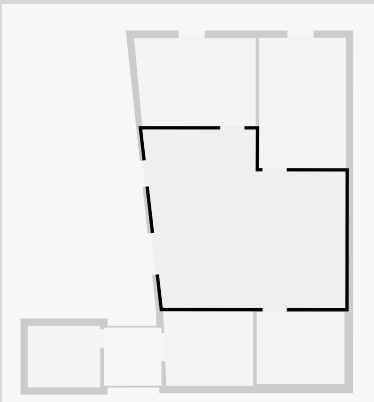



Küche

Breite 2.59 m
Länge: 3.10 m
Bodenfläche 7.89 m²
Umfang: 11.28 m

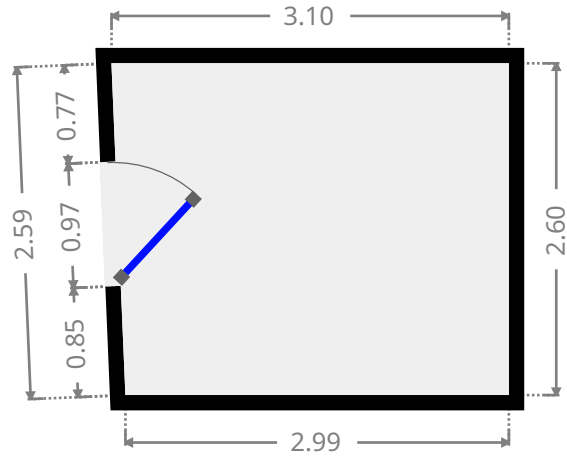
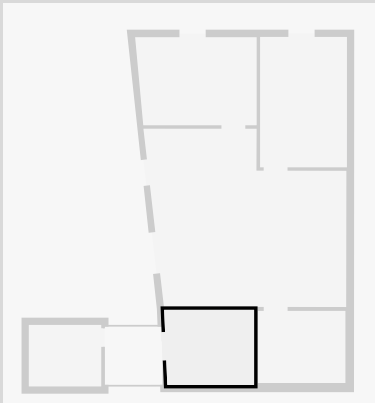

Zimmer 1

Breite 3.00 m
Länge: 4.50 m
Bodenfläche 13.49 m²
Umfang: 14.99 m

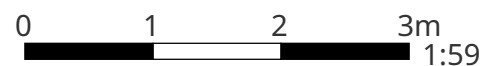
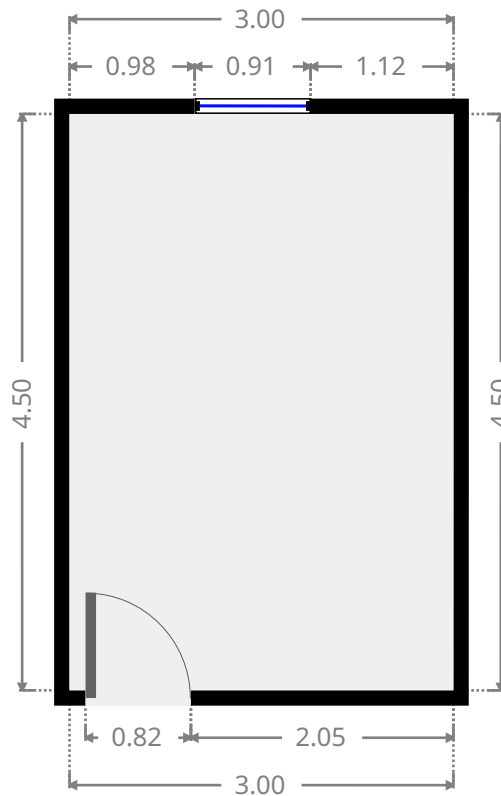
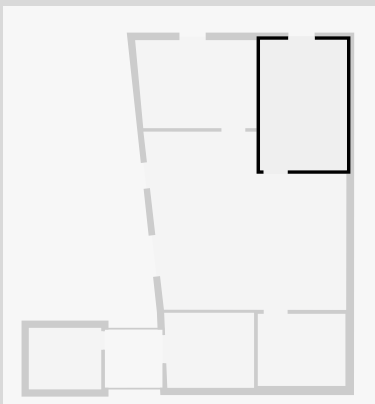

Sonstiges

Breite 3.04 m
 Länge: 4.19 m
 Bodenfläche 12.32 m²
 Umfang: 14.20 m

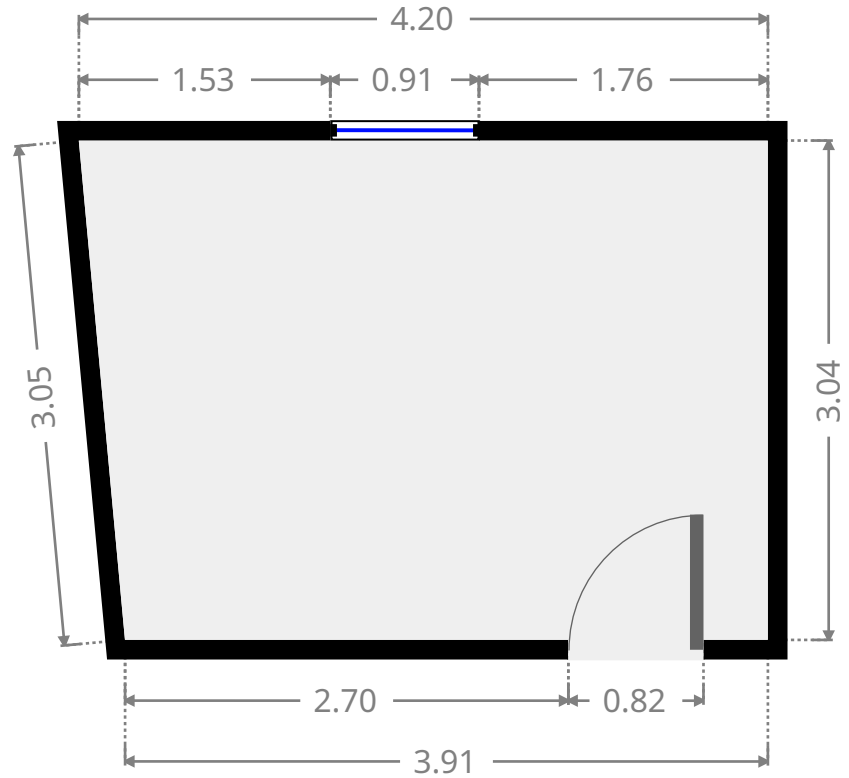
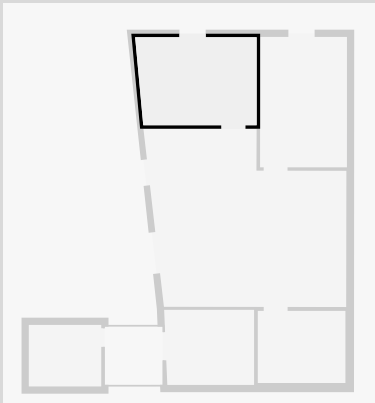

Terrasse

Breite 2.00 m
 Länge: 2.00 m
 Bodenfläche 4.02 m²
 Umfang: 8.02 m

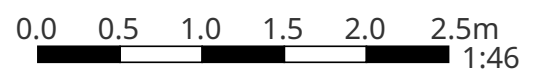
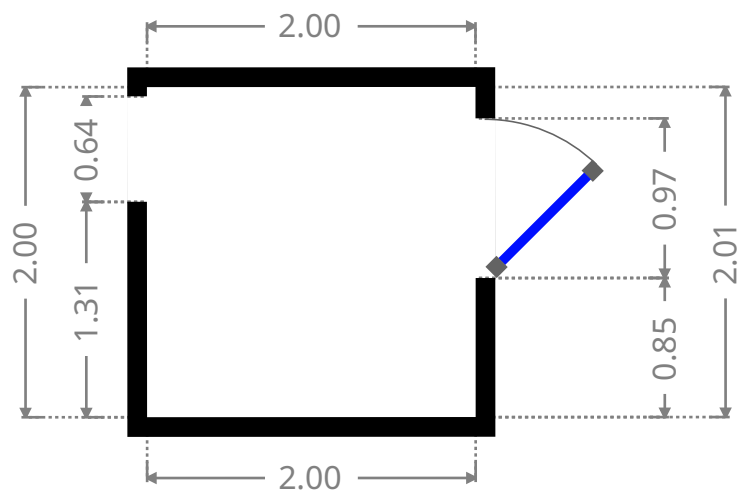
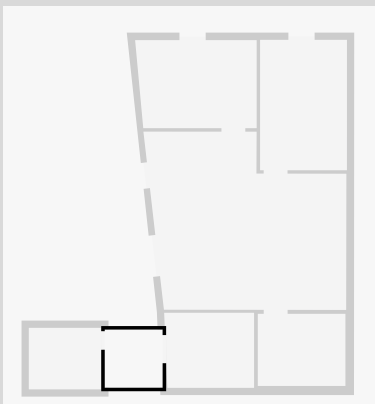

Schuppen

Breite 2.12 m
Länge 2.50 m
Bodenfläche 5.31 m²
Umfang 9.25 m

