

▼ **Arbeitszimmer**  
Erdgeschoss

BREITE: 4.43 m • LÄNGE: 2.25 m  
BEREICH: 9.97 m<sup>2</sup> • UMFANG: 13.36 m

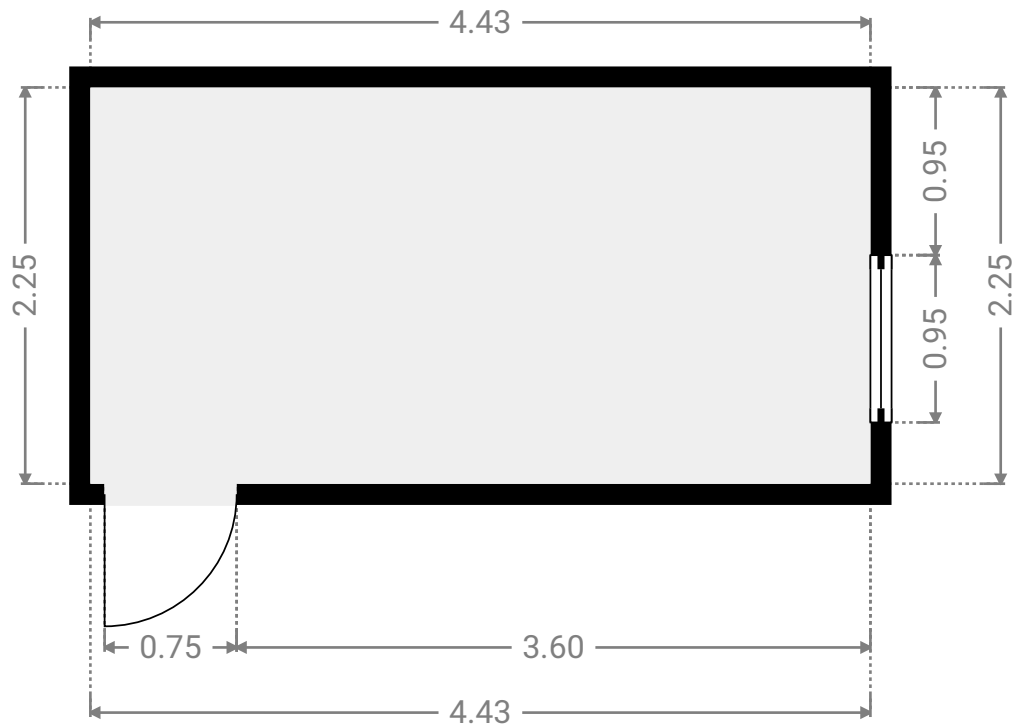
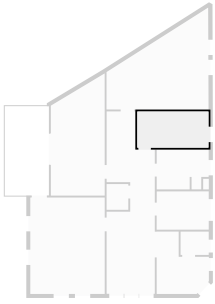

▼ **Badezimmer**  
Erdgeschoss

BREITE: 3.23 m • LÄNGE: 2.48 m  
BEREICH: 7.08 m<sup>2</sup> • UMFANG: 11.41 m

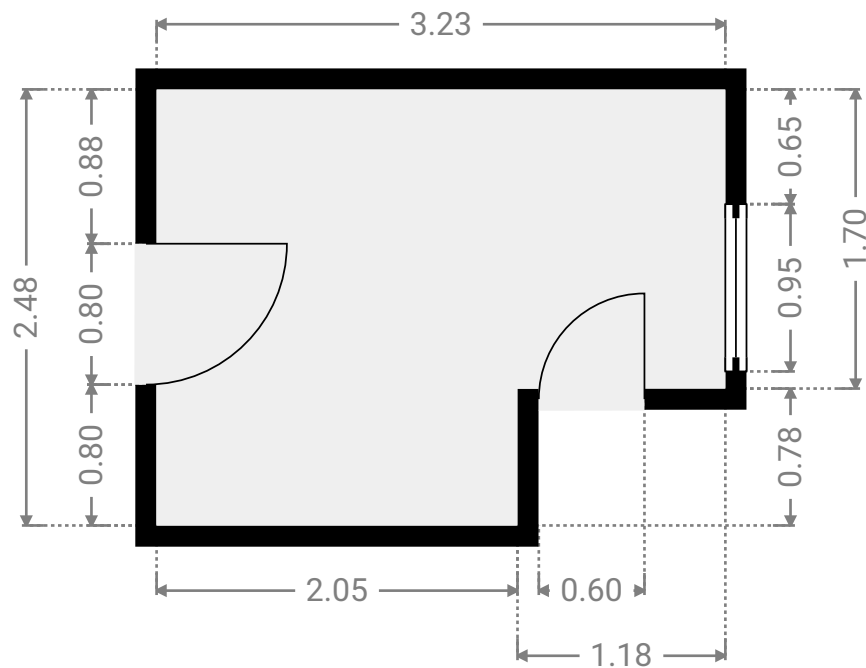
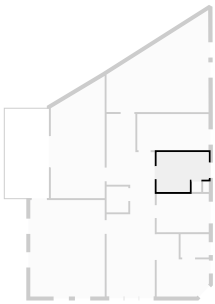

▼ **Diele**  
Erdgeschoss

BREITE: 3.25 m • LÄNGE: 3.88 m  
BEREICH: 9.34 m<sup>2</sup> • UMFANG: 13.80 m

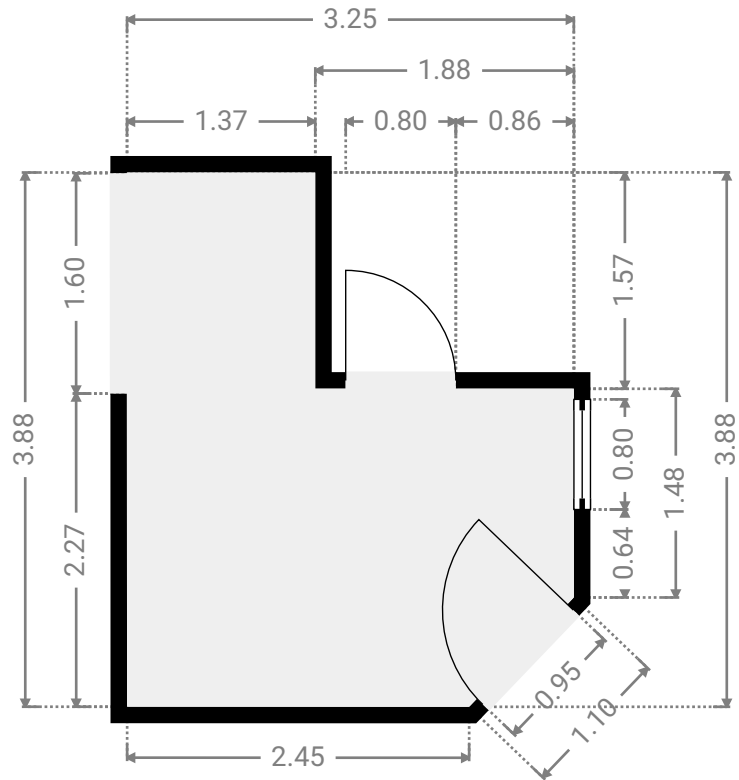
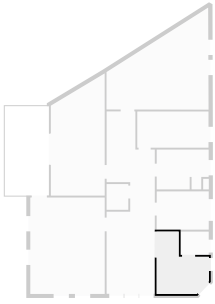

▼ **Gäste WC**  
Erdgeschoss

BREITE: 1.75 m • LÄNGE: 1.45 m  
BEREICH: 2.54 m<sup>2</sup> • UMFANG: 6.40 m

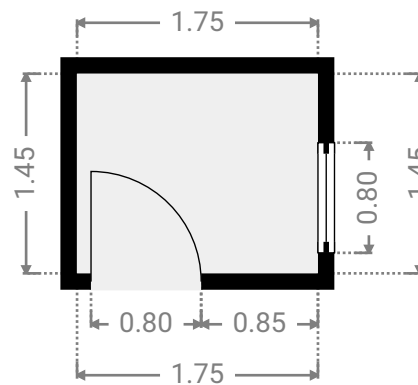
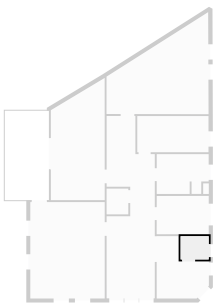

▼ **Heizung**  
Erdgeschoss

BREITE: 0.60 m • LÄNGE: 0.65 m  
BEREICH: 0.39 m<sup>2</sup> • UMFANG: 2.50 m

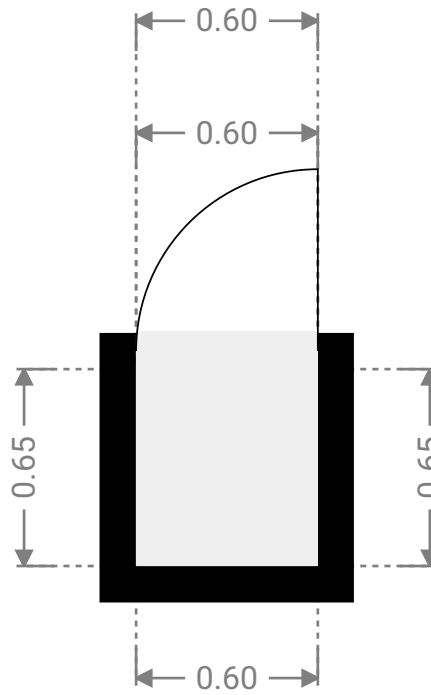
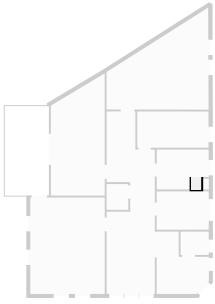

▼ **Kamin**  
Erdgeschoss

BREITE: 0.35 m • LÄNGE: 0.66 m  
BEREICH: 0.23 m<sup>2</sup> • UMFANG: 2.01 m

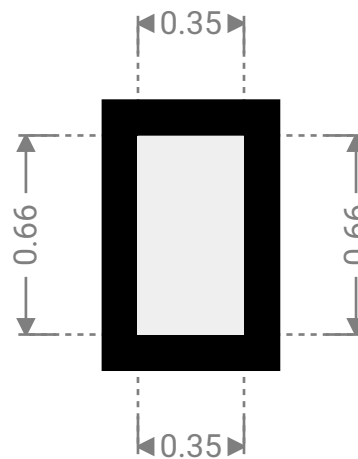
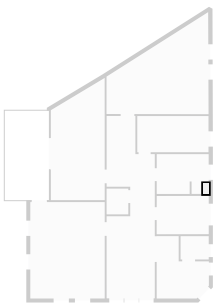

▼ **Kinderzimmer**  
Erdgeschoss

BREITE: 6.35 m • LÄNGE: 6.35 m  
BEREICH: 27.52 m<sup>2</sup> • UMFANG: 22.52 m

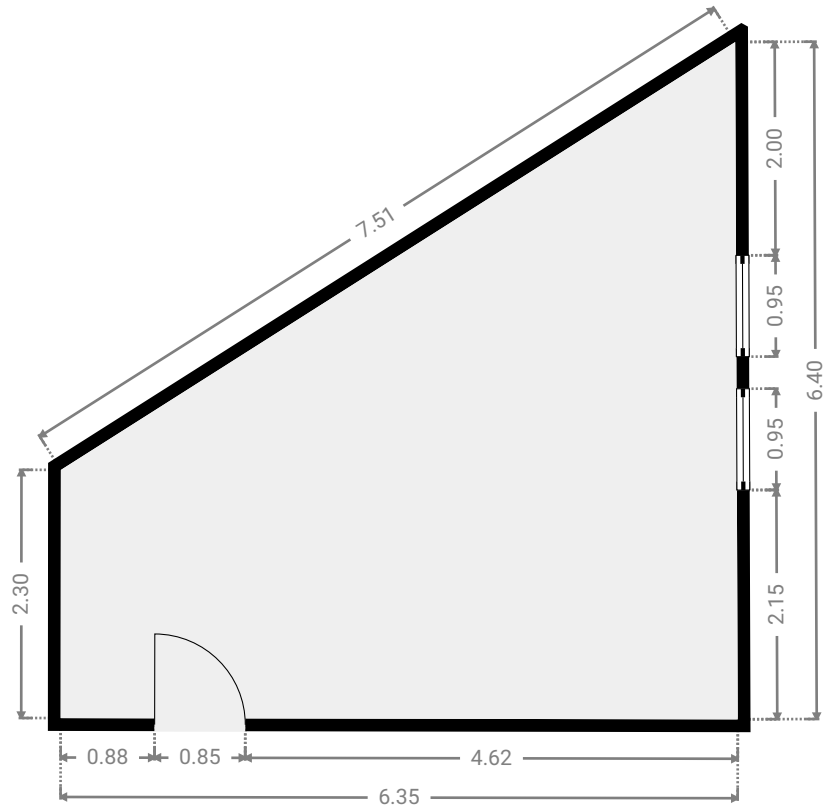
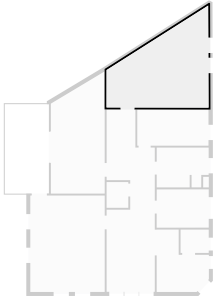

▼ **Küche**  
Erdgeschoss

BREITE: 3.24 m • LÄNGE: 2.38 m  
BEREICH: 7.70 m<sup>2</sup> • UMFANG: 11.23 m

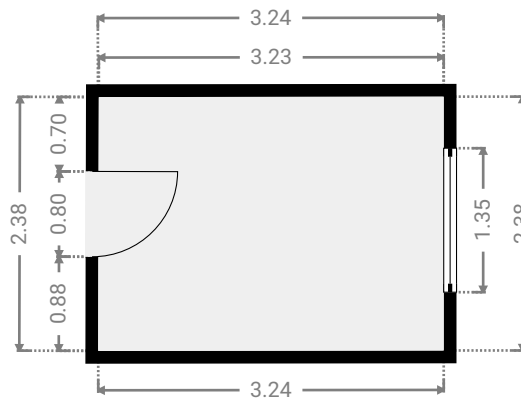
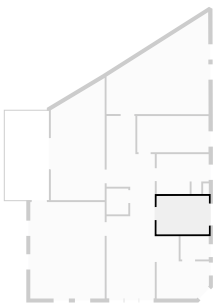

▼ **Schlafzimmer**  
Erdgeschoss

BREITE: 3.35 m • LÄNGE: 7.60 m  
BEREICH: 22.11 m<sup>2</sup> • UMFANG: 20.46 m

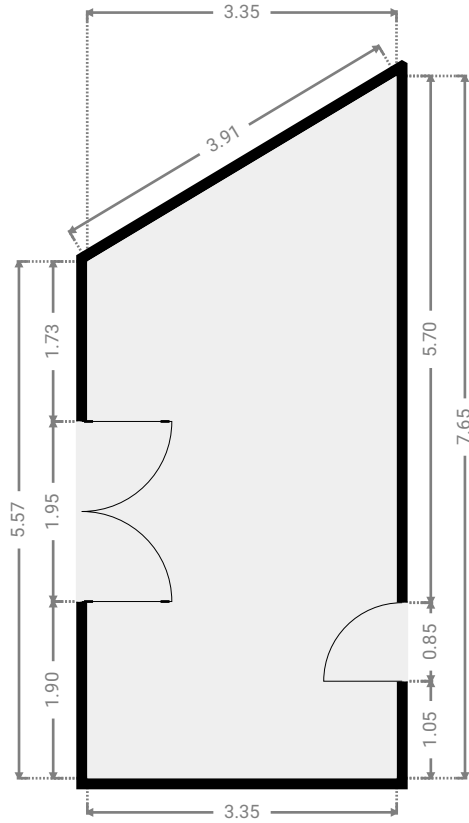
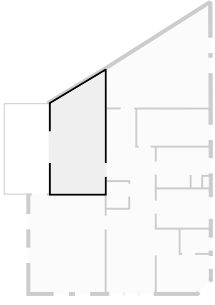

▼ **Terrasse**  
Erdgeschoss

BREITE: 2.75 m • LÄNGE: 5.57 m  
BEREICH: 15.31 m<sup>2</sup> • UMFANG: 16.64 m

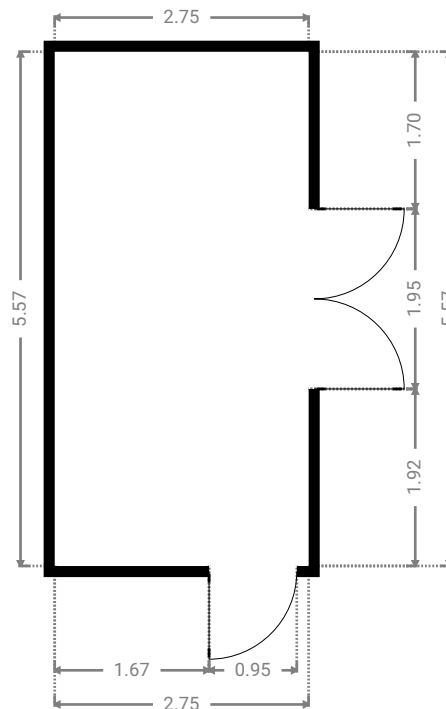
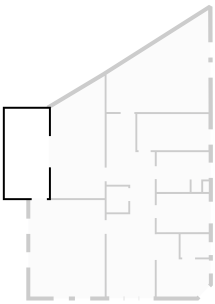

▼ **Wohndiele**  
Erdgeschoss

BREITE: 3.00 m • LÄNGE: 11.35 m  
BEREICH: 28.43 m<sup>2</sup> • UMFANG: 31.63 m

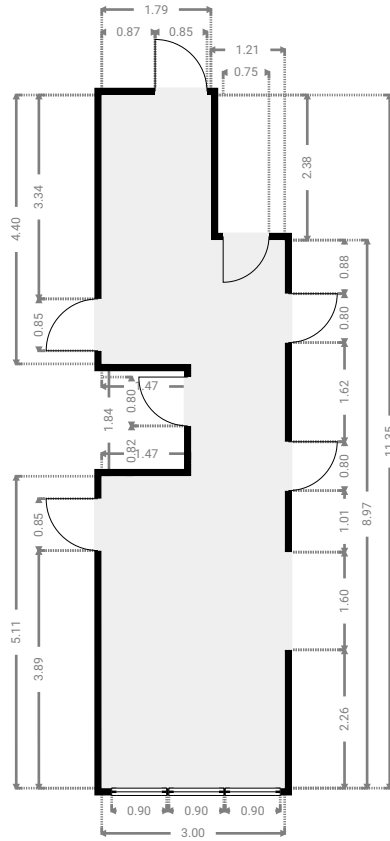
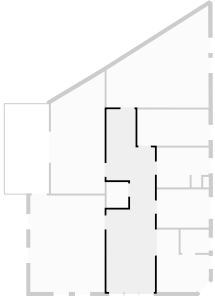

▼ **Abstellraum**  
Erdgeschoss

BREITE: 1.35 m • LÄNGE: 1.60 m  
BEREICH: 2.16 m<sup>2</sup> • UMFANG: 5.90 m

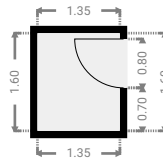
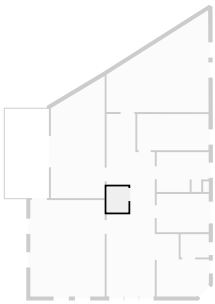

▼ **Wohnzimmer**  
Erdgeschoss

BREITE: 4.63 m • LÄNGE: 6.00 m  
BEREICH: 27.78 m<sup>2</sup> • UMFANG: 21.26 m

