

Ground Floor Level		
A001 - A3/A4/B1 Retail/food and drink	240 m <sup>2</sup>	c. 2583 ft <sup>2</sup>
B001 - A3/A4/B1 Retail/food and drink	250 m <sup>2</sup>	c. 2691 ft <sup>2</sup>
C001 - A1 Retail	223m <sup>2</sup>	c. 2400 ft <sup>2</sup>
C002 - A1 Retail	160m <sup>2</sup>	c. 1722 ft <sup>2</sup>
C003 - A1 Retail	145m <sup>2</sup>	c. 1560 ft <sup>2</sup>
<b>Total</b>	<b>1018 m<sup>2</sup></b>	<b>c. 10956 ft<sup>2</sup></b>
1 <sup>st</sup> Floor Level		
B101 - 2 Bed	67 m <sup>2</sup>	c. 721 ft <sup>2</sup>
B102 - 1 Bed	41 m <sup>2</sup>	c. 441 ft <sup>2</sup>
B106 - 2 Bed	58 m <sup>2</sup>	c. 624 ft <sup>2</sup>
B107 - Studio	23 m <sup>2</sup>	c. 247.5 ft <sup>2</sup>
B110 - Studio	23 m <sup>2</sup>	c. 247.5 ft <sup>2</sup>
C101 - 1 Bed	43 m <sup>2</sup>	c. 463 ft <sup>2</sup>
C102 - 1 Bed	43 m <sup>2</sup>	c. 463 ft <sup>2</sup>
C103 - 1 Bed	43 m <sup>2</sup>	c. 463 ft <sup>2</sup>
C104 - 1 Bed	43 m <sup>2</sup>	c. 463 ft <sup>2</sup>
C105 - 1 Bed	43 m <sup>2</sup>	c. 463 ft <sup>2</sup>
C106 - 1 Bed	43 m <sup>2</sup>	c. 463 ft <sup>2</sup>
C107 - 1 Bed	37 m <sup>2</sup>	c. 398 ft <sup>2</sup>
C108 - 2 Bed	67 m <sup>2</sup>	c. 721 ft <sup>2</sup>
C109 - 2 Bed	59 m <sup>2</sup>	c. 635 ft <sup>2</sup>
<b>Total</b>	<b>633</b>	<b>c. 6813 ft<sup>2</sup></b>
2 <sup>nd</sup> Floor Level		
B201 - 2 Bed	67 m <sup>2</sup>	c. 721 ft <sup>2</sup>
B202 - 1 Bed	41 m <sup>2</sup>	c. 441 ft <sup>2</sup>
B203 - 2 Bed	57 m <sup>2</sup>	c. 614 ft <sup>2</sup>
B206 - 2 Bed	58 m <sup>2</sup>	c. 624 ft <sup>2</sup>
B207 - Studio	23 m <sup>2</sup>	c. 247.5 ft <sup>2</sup>
B210 - Studio	23 m <sup>2</sup>	c. 247.5 ft <sup>2</sup>
C201 - 1 Bed	43 m <sup>2</sup>	c. 463 ft <sup>2</sup>
C202 - 1 Bed	43 m <sup>2</sup>	c. 463 ft <sup>2</sup>
C203 - 1 Bed	43 m <sup>2</sup>	c. 463 ft <sup>2</sup>
C204 - 1 Bed	43 m <sup>2</sup>	c. 463 ft <sup>2</sup>
C205 - 1 Bed	43 m <sup>2</sup>	c. 463 ft <sup>2</sup>
C206 - 1 Bed	43 m <sup>2</sup>	c. 463 ft <sup>2</sup>
C207 - 1 Bed	37 m <sup>2</sup>	c. 398 ft <sup>2</sup>
C208 - 2 Bed	67 m <sup>2</sup>	c. 721 ft <sup>2</sup>
C209 - 2 Bed	59 m <sup>2</sup>	c. 635 ft <sup>2</sup>
<b>Total</b>	<b>690</b>	<b>c. 7427 ft<sup>2</sup></b>
3 <sup>rd</sup> Floor Level		
B301 - 2 Bed	67 m <sup>2</sup>	c. 721 ft <sup>2</sup>
B302 - 1 Bed	41 m <sup>2</sup>	c. 441 ft <sup>2</sup>
B303 - 2 Bed	57 m <sup>2</sup>	c. 614 ft <sup>2</sup>
B304 - 2 Bed	69 m <sup>2</sup>	c. 742.5 ft <sup>2</sup>
B305 - 2 Bed	68.5 m <sup>2</sup>	c. 737 ft <sup>2</sup>
B306 - 2 Bed	58 m <sup>2</sup>	c. 624 ft <sup>2</sup>
B307 - Studio	23 m <sup>2</sup>	c. 247.5 ft <sup>2</sup>
B310 - Studio	23 m <sup>2</sup>	c. 247.5 ft <sup>2</sup>
B308 - Studio	36.5 m <sup>2</sup>	c. 392.5 ft <sup>2</sup>
B309 - Studio	34.5 m <sup>2</sup>	c. 371 ft <sup>2</sup>
C301 - 1 Bed	43 m <sup>2</sup>	c. 463 ft <sup>2</sup>
C302 - 1 Bed	43 m <sup>2</sup>	c. 463 ft <sup>2</sup>
C303 - 1 Bed	43 m <sup>2</sup>	c. 463 ft <sup>2</sup>
C304 - 1 Bed	43 m <sup>2</sup>	c. 463 ft <sup>2</sup>
C305 - 1 Bed	43 m <sup>2</sup>	c. 463 ft <sup>2</sup>
C306 - 1 Bed	43 m <sup>2</sup>	c. 463 ft <sup>2</sup>
C307 - 1 Bed	37 m <sup>2</sup>	c. 398 ft <sup>2</sup>
C308 - 2 Bed	67 m <sup>2</sup>	c. 721 ft <sup>2</sup>
C309 - 2 Bed	59 m <sup>2</sup>	c. 635 ft <sup>2</sup>
<b>Total</b>	<b>898.5</b>	<b>c. 9669 ft<sup>2</sup></b>

4 <sup>th</sup> Floor Level		
B401 - 2 Bed	67 m <sup>2</sup>	c. 721 ft <sup>2</sup>
B402 - 1 Bed	41 m <sup>2</sup>	c. 441 ft <sup>2</sup>
B403 - 2 Bed	57 m <sup>2</sup>	c. 614 ft <sup>2</sup>
B404 - 2 Bed	69 m <sup>2</sup>	c. 742.5 ft <sup>2</sup>
B405 - 2 Bed	68.5 m <sup>2</sup>	c. 737 ft <sup>2</sup>
B406 - 2Bed	58 m <sup>2</sup>	c. 624 ft <sup>2</sup>
B407 - Studio	23 m <sup>2</sup>	c. 247.5 ft <sup>2</sup>
B410 - Studio	23 m <sup>2</sup>	c. 247.5 ft <sup>2</sup>
B408 - Studio	36.5 m <sup>2</sup>	c. 392.5 ft <sup>2</sup>
B409 - Studio	34.5 m <sup>2</sup>	c. 371 ft <sup>2</sup>
C401 - 1 Bed	43 m <sup>2</sup>	c. 463 ft <sup>2</sup>
C402 - 1 Bed	43 m <sup>2</sup>	c. 463 ft <sup>2</sup>
C403 - 1 Bed	43 m <sup>2</sup>	c. 463 ft <sup>2</sup>
C404 - 1 Bed	43 m <sup>2</sup>	c. 463 ft <sup>2</sup>
C405 - 1 Bed	43 m <sup>2</sup>	c. 463 ft <sup>2</sup>
C406 - 1 Bed	43 m <sup>2</sup>	c. 463 ft <sup>2</sup>
C407 - 1 Bed	37 m <sup>2</sup>	c. 398 ft <sup>2</sup>
C408 - 2 Bed	67 m <sup>2</sup>	c. 721 ft <sup>2</sup>
C409 - 2 Bed	59 m <sup>2</sup>	c. 635 ft <sup>2</sup>
<b>Total</b>	<b>898.5</b>	<b>c. 9669 ft<sup>2</sup></b>
5 <sup>th</sup> Floor Level		
B501 - 2 Bed	78 m <sup>2</sup>	c. 840 ft <sup>2</sup>
B503 - 2 Bed	57 m <sup>2</sup>	c. 614 ft <sup>2</sup>
B504 - 2 Bed	69 m <sup>2</sup>	c. 742.5 ft <sup>2</sup>
B505 - 2 Bed	68.5 m <sup>2</sup>	c. 737 ft <sup>2</sup>
B506 - 2 Bed	58 m <sup>2</sup>	c. 624 ft <sup>2</sup>
B507 - 1 Bed	44 m <sup>2</sup>	c. 474 ft <sup>2</sup>
B508 - Studio	36.5 m <sup>2</sup>	c. 392.5 ft <sup>2</sup>
B509 - Studio	34.5 m <sup>2</sup>	c. 371 ft <sup>2</sup>
C501 - 1 Bed	40 m <sup>2</sup>	c. 430.5 ft <sup>2</sup>
C502 - 1 Bed	40 m <sup>2</sup>	c. 430.5 ft <sup>2</sup>
C503 - 1 Bed	40 m <sup>2</sup>	c. 430.5 ft <sup>2</sup>
C504 - 1 Bed	40m <sup>2</sup>	c. 430.5 ft <sup>2</sup>
C505 - 1 Bed	40 m <sup>2</sup>	c. 430.5 ft <sup>2</sup>
C506 - 1 Bed	40 m <sup>2</sup>	c. 430.5 ft <sup>2</sup>
C507 - 1 Bed	32 m <sup>2</sup>	c. 344 ft <sup>2</sup>
C508 - 2 Bed	63 m <sup>2</sup>	c. 678 ft <sup>2</sup>
<b>Total</b>	<b>780.5</b>	<b>c. 8400 ft<sup>2</sup></b>
6 <sup>th</sup> Floor Level		
B603- 2 Bed	57 m <sup>2</sup>	c. 614 ft <sup>2</sup>
B604- 2 Bed	69 m <sup>2</sup>	c. 742.5 ft <sup>2</sup>
B605- 2 Bed	68.5 m <sup>2</sup>	c. 737 ft <sup>2</sup>
B606- 2 Bed	58 m <sup>2</sup>	c. 624 ft <sup>2</sup>
<b>Total</b>	<b>252.5 m<sup>2</sup></b>	<b>c. 2717.5 ft<sup>2</sup></b>
7 <sup>th</sup> Floor Level		
B703- 2 Bed	57 m <sup>2</sup>	c. 614 ft <sup>2</sup>
B704- 2 Bed	69 m <sup>2</sup>	c. 742.5 ft <sup>2</sup>
B705- 2 Bed	68.5 m <sup>2</sup>	c. 737 ft <sup>2</sup>
B706- 2 Bed	58 m <sup>2</sup>	c. 624 ft <sup>2</sup>
<b>Total</b>	<b>252.5 m<sup>2</sup></b>	<b>c. 2717.5 ft<sup>2</sup></b>
8 <sup>th</sup> Floor Level		
B803- 2 Bed	57 m <sup>2</sup>	c. 614 ft <sup>2</sup>
B804- 2 Bed	69 m <sup>2</sup>	c. 742.5 ft <sup>2</sup>
B805- 2 Bed	68.5 m <sup>2</sup>	c. 737 ft <sup>2</sup>
B806- 2 Bed	58 m <sup>2</sup>	c. 624 ft <sup>2</sup>
<b>Total</b>	<b>252.5 m<sup>2</sup></b>	<b>c. 2717.5 ft<sup>2</sup></b>
9 <sup>th</sup> Floor Level		
B903- 2 Bed	57 m <sup>2</sup>	c. 614 ft <sup>2</sup>
B904- 2 Bed	69 m <sup>2</sup>	c. 742.5 ft <sup>2</sup>
B905- 2 Bed	68.5 m <sup>2</sup>	c. 737 ft <sup>2</sup>
B906- 2 Bed	58 m <sup>2</sup>	c. 624 ft <sup>2</sup>
<b>Total</b>	<b>252.5 m<sup>2</sup></b>	<b>c. 2717.5 ft<sup>2</sup></b>

10 <sup>th</sup> Floor Level		
B1003- 2 Bed	57 m <sup>2</sup>	c. 614 ft <sup>2</sup>
B1004- 2 Bed	69 m <sup>2</sup>	c. 742.5 ft <sup>2</sup>
B1005- 2 Bed	68.5 m <sup>2</sup>	c. 737 ft <sup>2</sup>
B1006- 2 Bed	58 m <sup>2</sup>	c. 624 ft <sup>2</sup>
<b>Total</b>	<b>252.5 m<sup>2</sup></b>	<b>c. 2717.5 ft<sup>2</sup></b>
11 <sup>th</sup> Floor Level		
B1103- 2 Bed	57 m <sup>2</sup>	c. 614 ft <sup>2</sup>
B1104- 2 Bed	69 m <sup>2</sup>	c. 742.5 ft <sup>2</sup>
B1105- 2 Bed	68.5 m <sup>2</sup>	c. 737 ft <sup>2</sup>
B1006- 2 Bed	58 m <sup>2</sup>	c. 624 ft <sup>2</sup>
<b>Total</b>	<b>252.5 m<sup>2</sup></b>	<b>c. 2717.5 ft<sup>2</sup></b>
12 <sup>th</sup> Floor Level		
B1203- 2 Bed	57 m <sup>2</sup>	c. 614 ft <sup>2</sup>
B1204- 2 Bed	69 m <sup>2</sup>	c. 742.5 ft <sup>2</sup>
B1205- 2 Bed	68.5 m <sup>2</sup>	c. 737 ft <sup>2</sup>
B1206- 2 Bed	58 m <sup>2</sup>	c. 624 ft <sup>2</sup>
<b>Total</b>	<b>252.5 m<sup>2</sup></b>	<b>c. 2717.5 ft<sup>2</sup></b>
13 <sup>th</sup> Floor Level		
B1303- 2 Bed	57 m <sup>2</sup>	c. 614 ft <sup>2</sup>
B1304- 2 Bed	69 m <sup>2</sup>	c. 742.5 ft <sup>2</sup>
B1305- 2 Bed	68.5 m <sup>2</sup>	c. 737 ft <sup>2</sup>
B1306- 2 Bed	58 m <sup>2</sup>	c. 624 ft <sup>2</sup>
<b>Total</b>	<b>252.5 m<sup>2</sup></b>	<b>c. 2717.5 ft<sup>2</sup></b>
14 <sup>th</sup> Floor Level		
B1403- 2 Bed	57 m <sup>2</sup>	c. 614 ft <sup>2</sup>
B1404- 2 Bed	69 m <sup>2</sup>	c. 742.5 ft <sup>2</sup>
B1405- 2 Bed	68.5 m <sup>2</sup>	c. 737 ft <sup>2</sup>
B1406- 2 Bed	58 m <sup>2</sup>	c. 624 ft <sup>2</sup>
<b>Total</b>	<b>252.5 m<sup>2</sup></b>	<b>c. 2717.5 ft<sup>2</sup></b>
15 <sup>th</sup> Floor Level		
B1503- 2 Bed	57 m <sup>2</sup>	c. 614 ft <sup>2</sup>
B1504- 2 Bed	69 m <sup>2</sup>	c. 742.5 ft <sup>2</sup>
B1505- 3 Bed	68.5 m <sup>2</sup>	c. 737 ft <sup>2</sup>
B1506- 2 Bed	58 m <sup>2</sup>	c. 624 ft <sup>2</sup>
<b>Total</b>	<b>252.5 m<sup>2</sup></b>	<b>c. 2717.5 ft<sup>2</sup></b>
<b>Grand Total (all types)</b>	<b>6425.5 m<sup>2</sup></b>	<b>c. 69155 ft<sup>2</sup></b>
<b>A002 - 4 Bed Townhouse</b>	<b>96 m<sup>2</sup></b>	<b>c. 1030 ft<sup>2</sup></b>
A101 to A102- Office Space	271 m <sup>2</sup>	c. 2915 ft <sup>2</sup>
A201 to A202 - Office space	271 m <sup>2</sup>	c. 2915 ft <sup>2</sup>
A301 to A302 - Office space	242 m <sup>2</sup>	c. 2600 ft <sup>2</sup>
<b>Total</b>	<b>784 m<sup>2</sup></b>	<b>c. 8437 ft<sup>2</sup></b>
<b>Grand Total</b>	<b>8334 m<sup>2</sup></b>	<b>c. 89688 ft<sup>2</sup></b>

Total Number of Residential		
Studio	14	
1 Bed Apartments	39	
2 Bed Apartments	69	
4 Bed Townhouse	1	
<b>Grand Total</b>	<b>123</b>	

1st Floor C109  
2nd Floor C209  
3rd Floor C309  
4th Floor C409

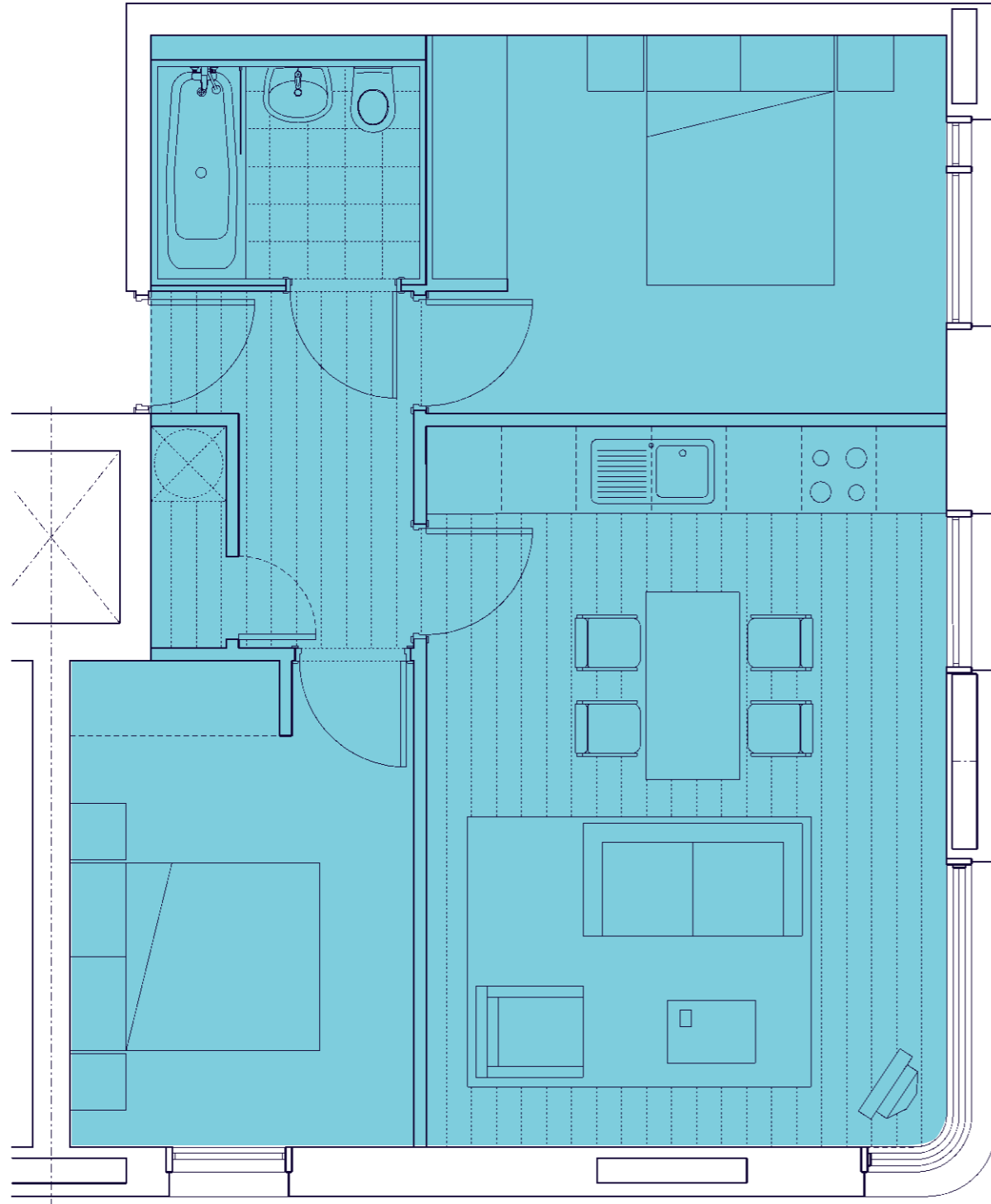

01

2 BF Bedroom, Type A  
Total = 4

59 m<sup>2</sup>  
1:50

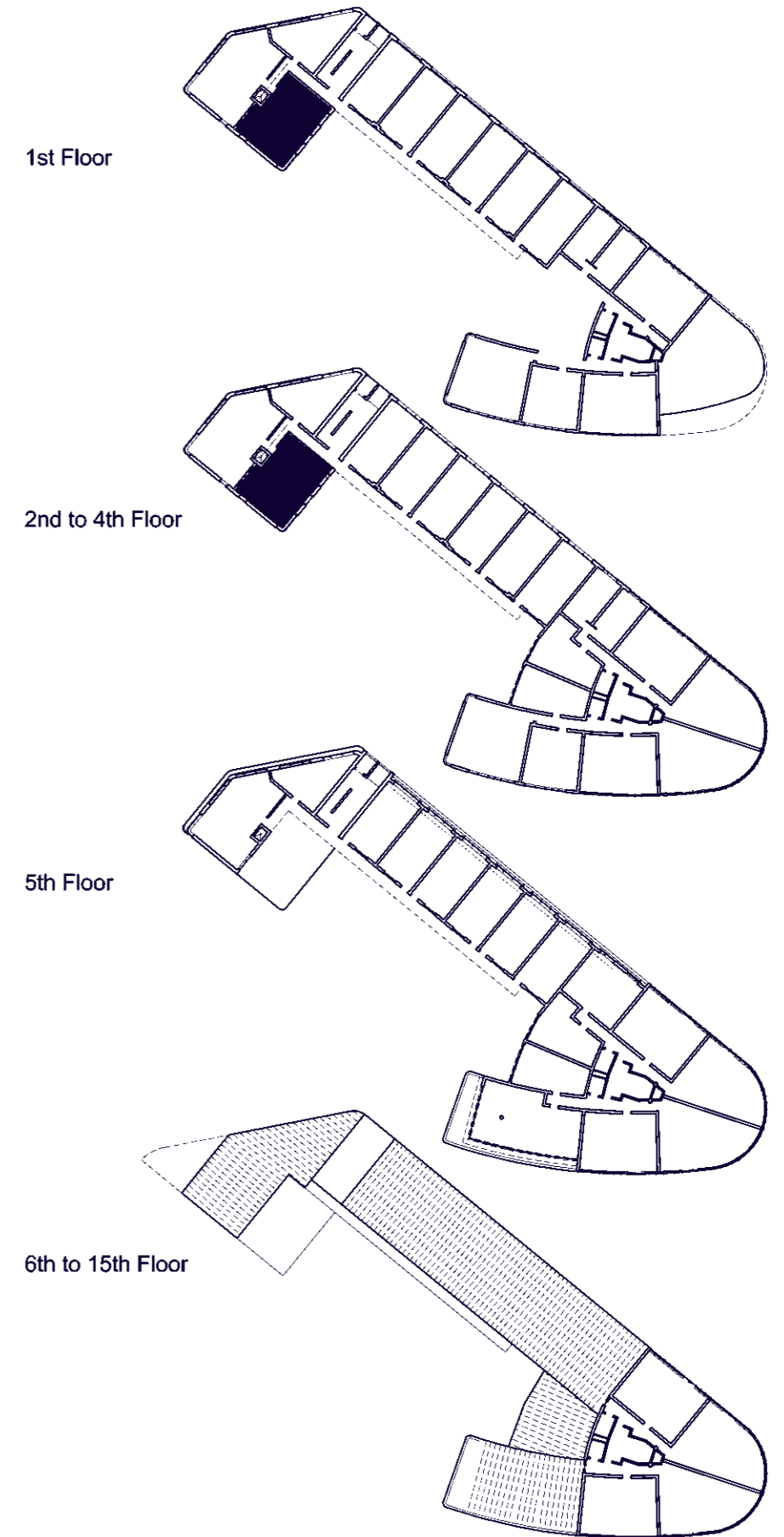

1st Floor C108  
 2nd Floor C208  
 3rd Floor C308  
 4th Floor C408

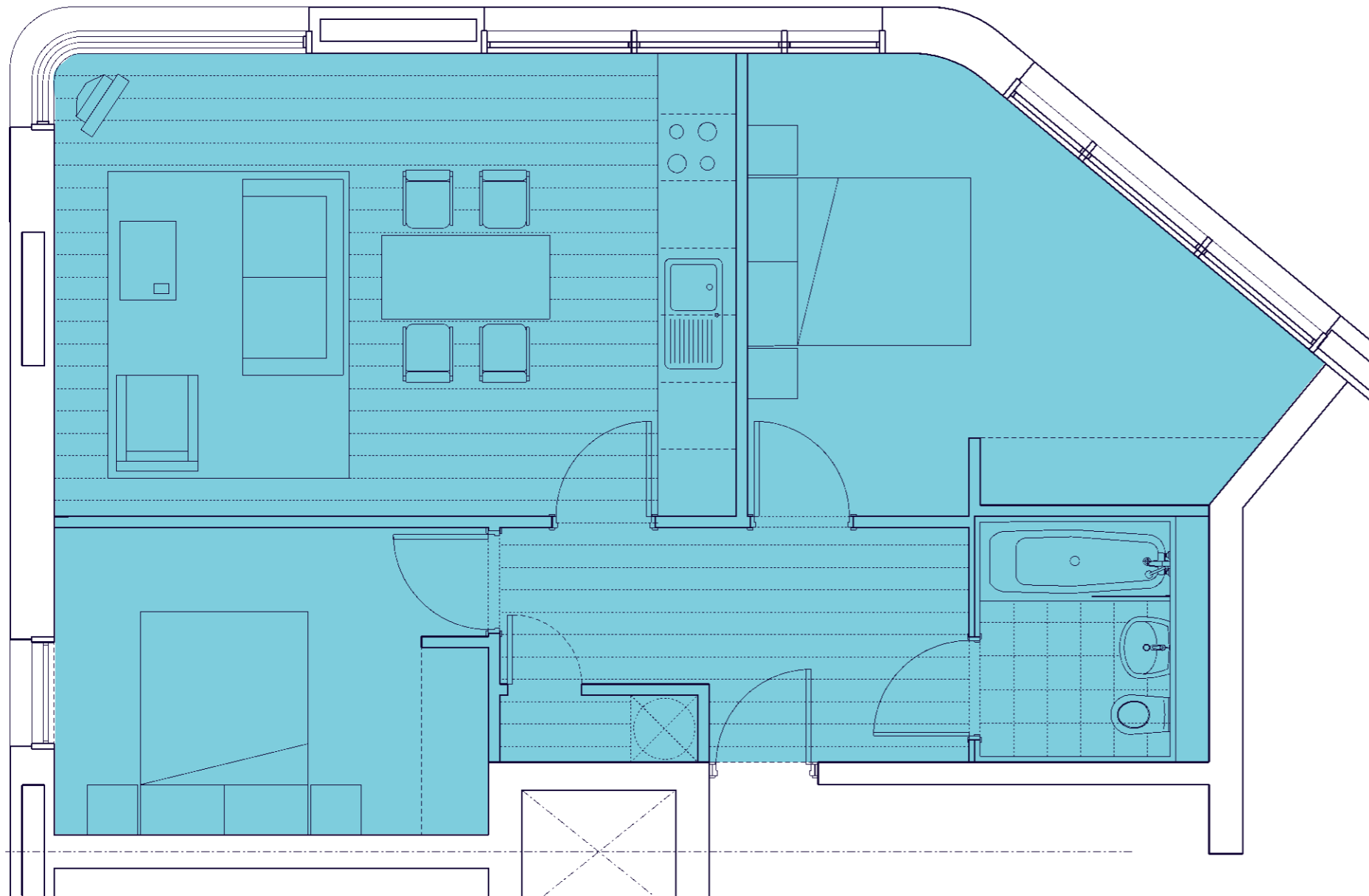

1st Floor

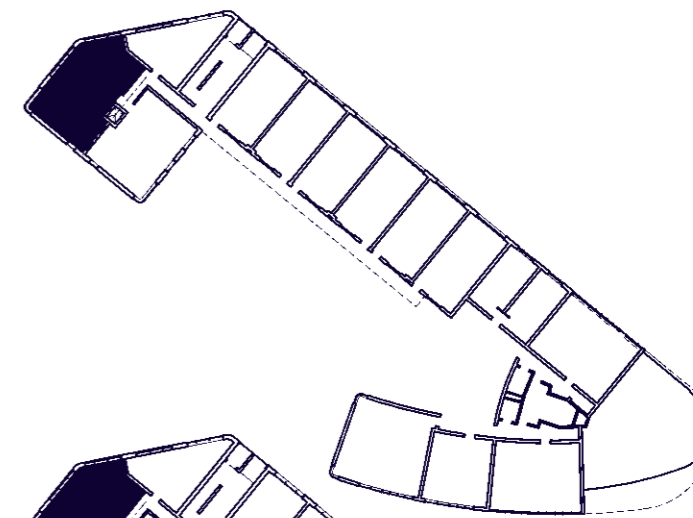

2nd to 4th Floor

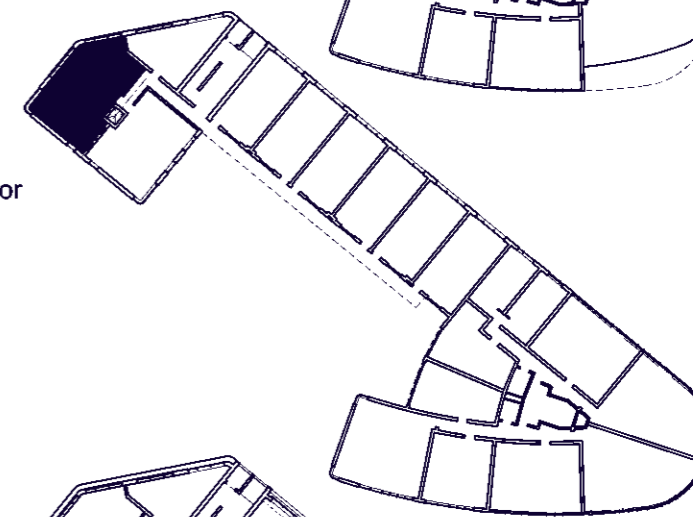

5th Floor

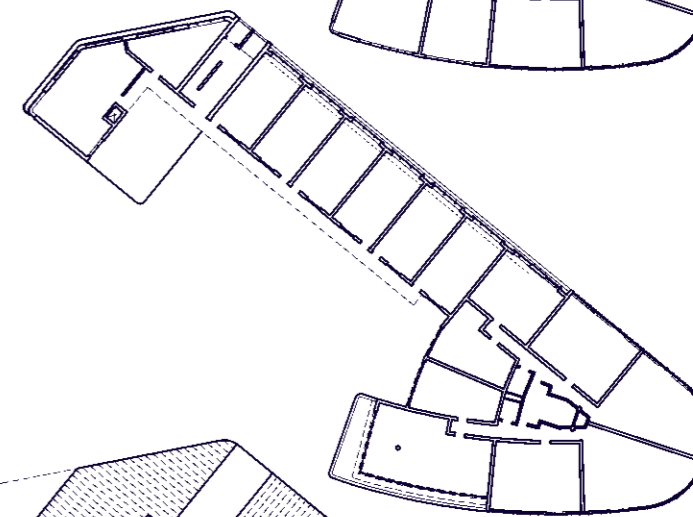

6th to 15th Floor

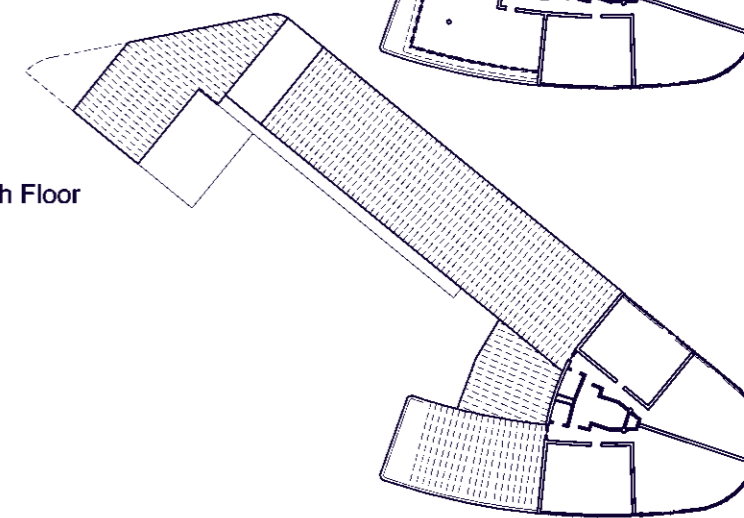

01

2 BF Bedroom, Type B  
 Total =4

67 m<sup>2</sup>  
 1:50

1st Floor B106 9th Floor B906  
 2nd Floor B206 10th Floor B1006  
 3rd Floor B306 11th Floor B1106  
 4th Floor B406 12th Floor B1206  
 5th Floor B506 13th Floor B1306  
 6th Floor B606 14th Floor B1406  
 7th Floor B706 15th Floor B1506  
 8th Floor B806

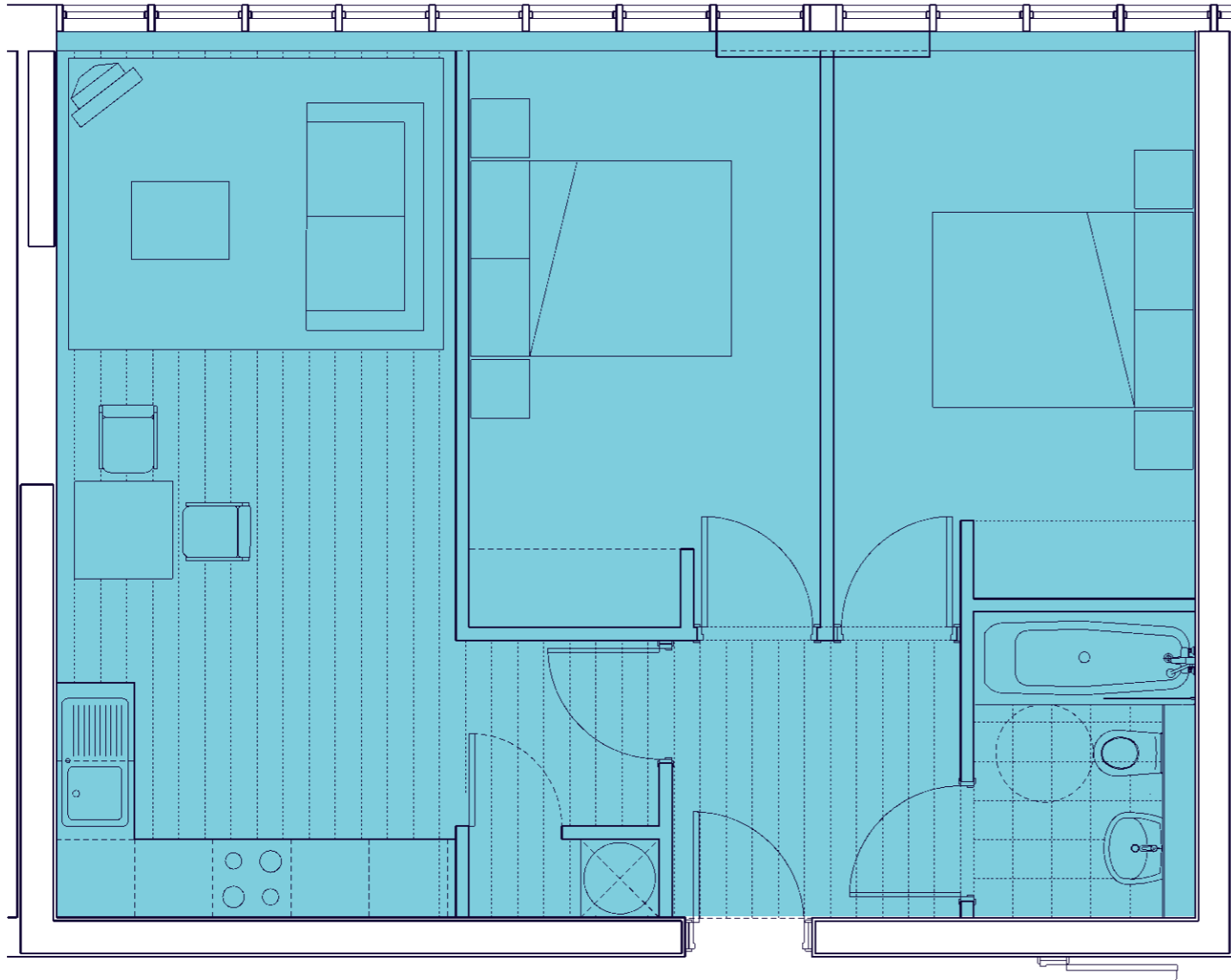

01

2 BF Bedroom, Type F  
Total = 15

58 m2  
1:50

1st Floor

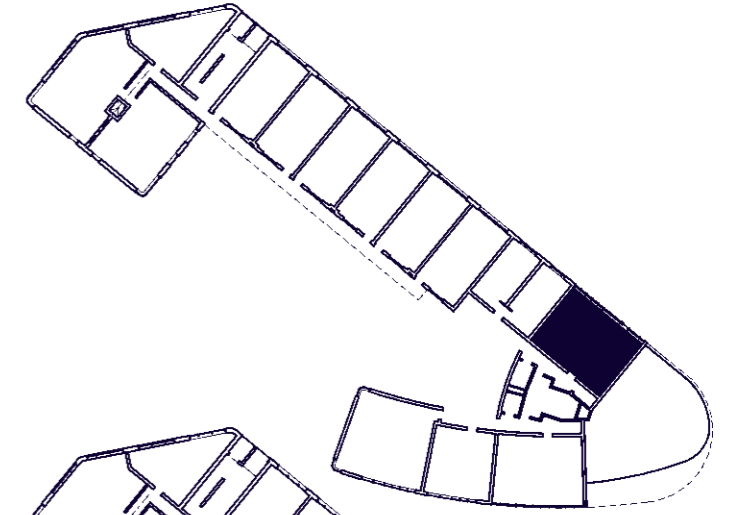

2nd to 4th Floor

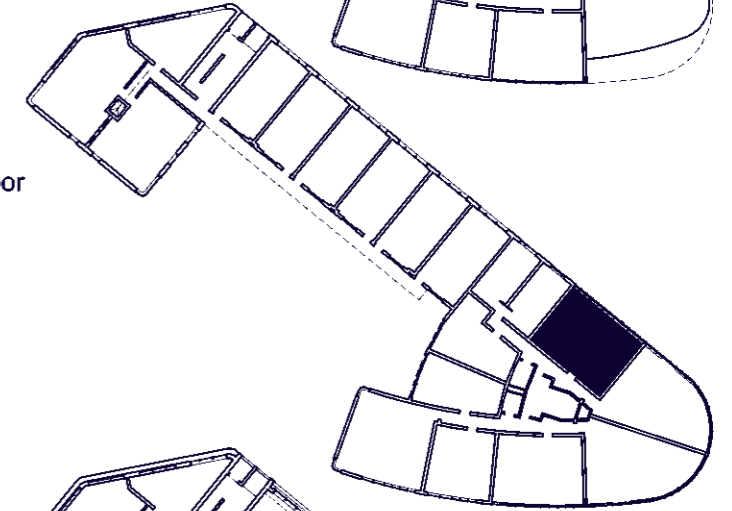

5th Floor

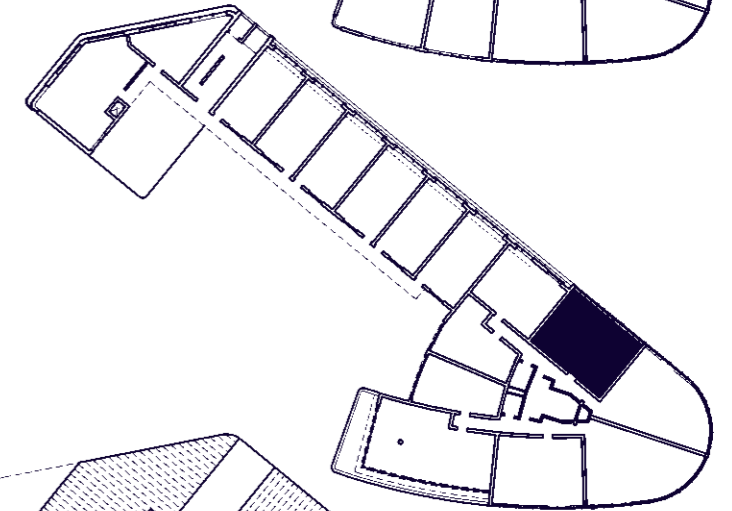

6th to 15th Floor

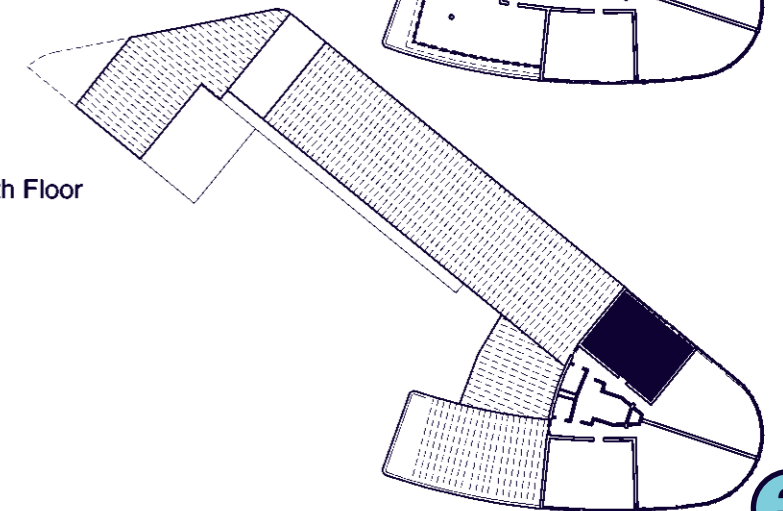

1st Floor C107  
2nd Floor C207  
3rd Floor C307  
4th Floor C407

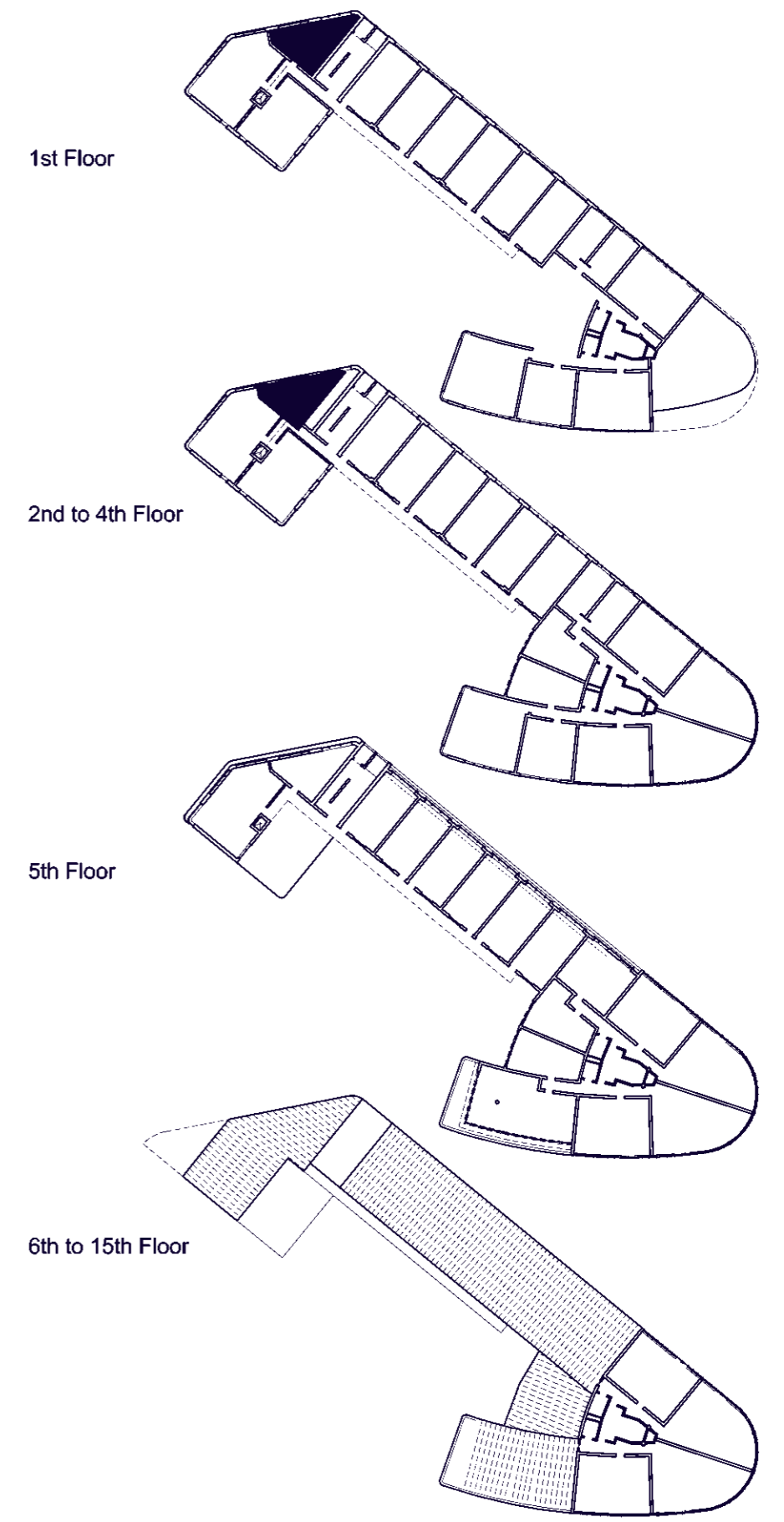
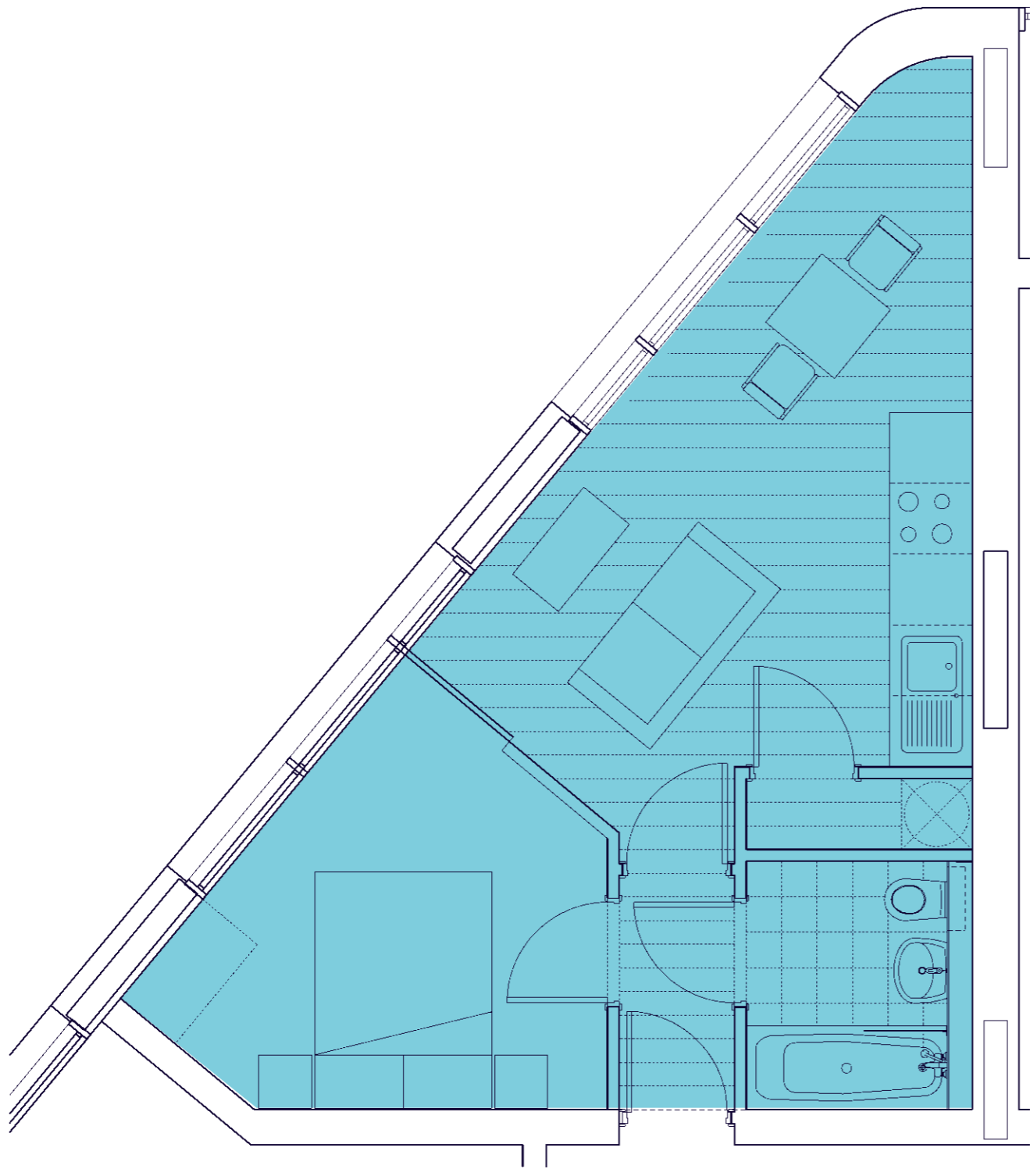

01 1 BF Bedroom, Type C  
Total =4

37 m<sup>2</sup>  
1:50



- 1st Floor B107
- 1st Floor B110
- 2nd Floor B207
- 2nd Floor B210
- 3rd Floor B307
- 3rd Floor B310
- 4th Floor B407
- 4th Floor B407

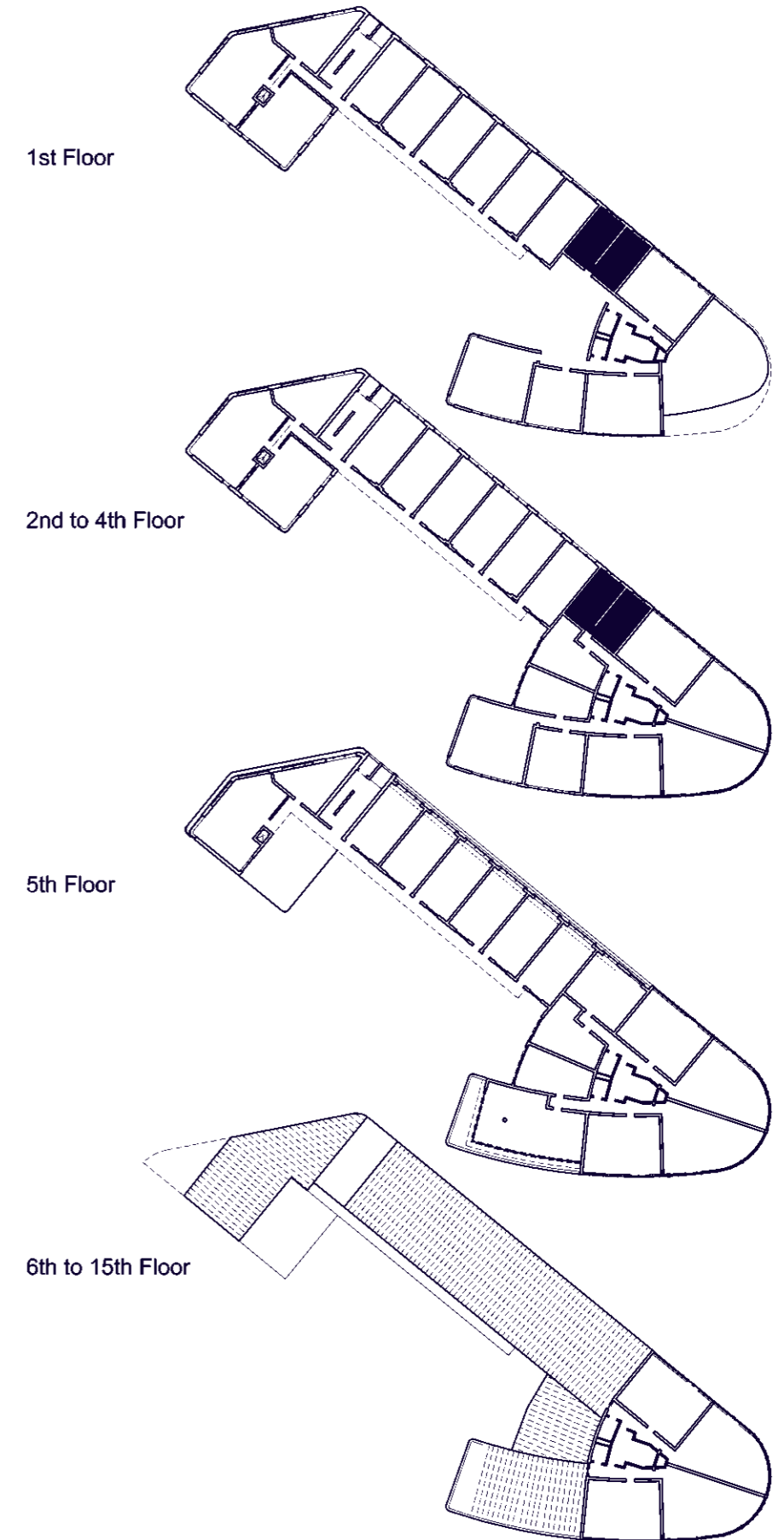
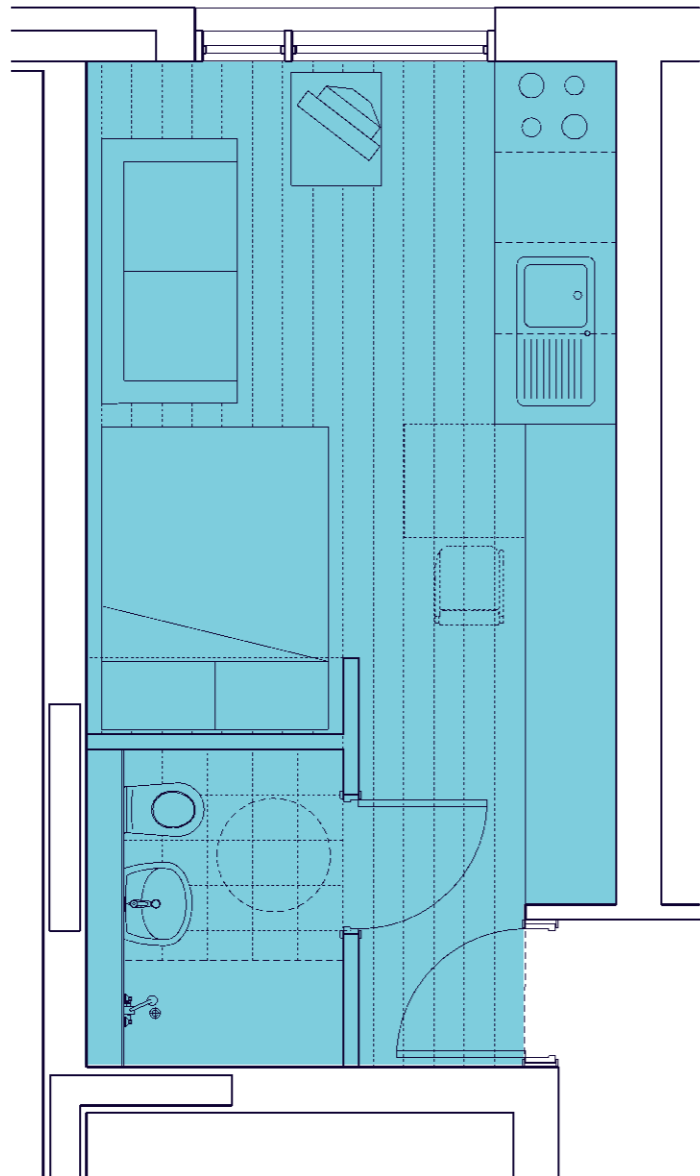

01

1 SF Bedroom, Type E  
Total =8

23 m<sup>2</sup>  
1:50

5th Floor B501

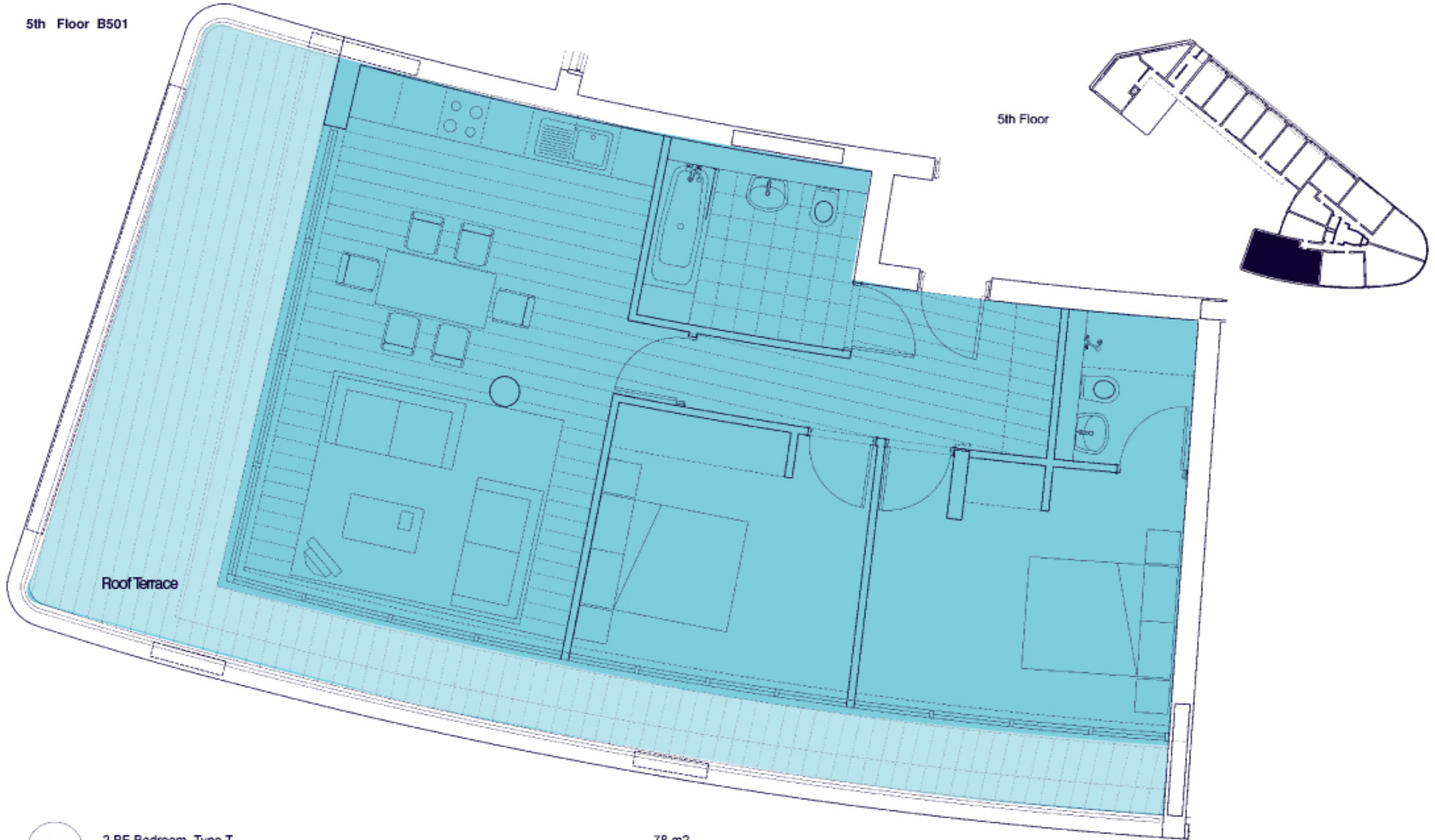

5th Floor

Roof Terrace

01

2 BF Bedroom, Type T  
Total = 1

78 m2  
1:50

5th Floor B507

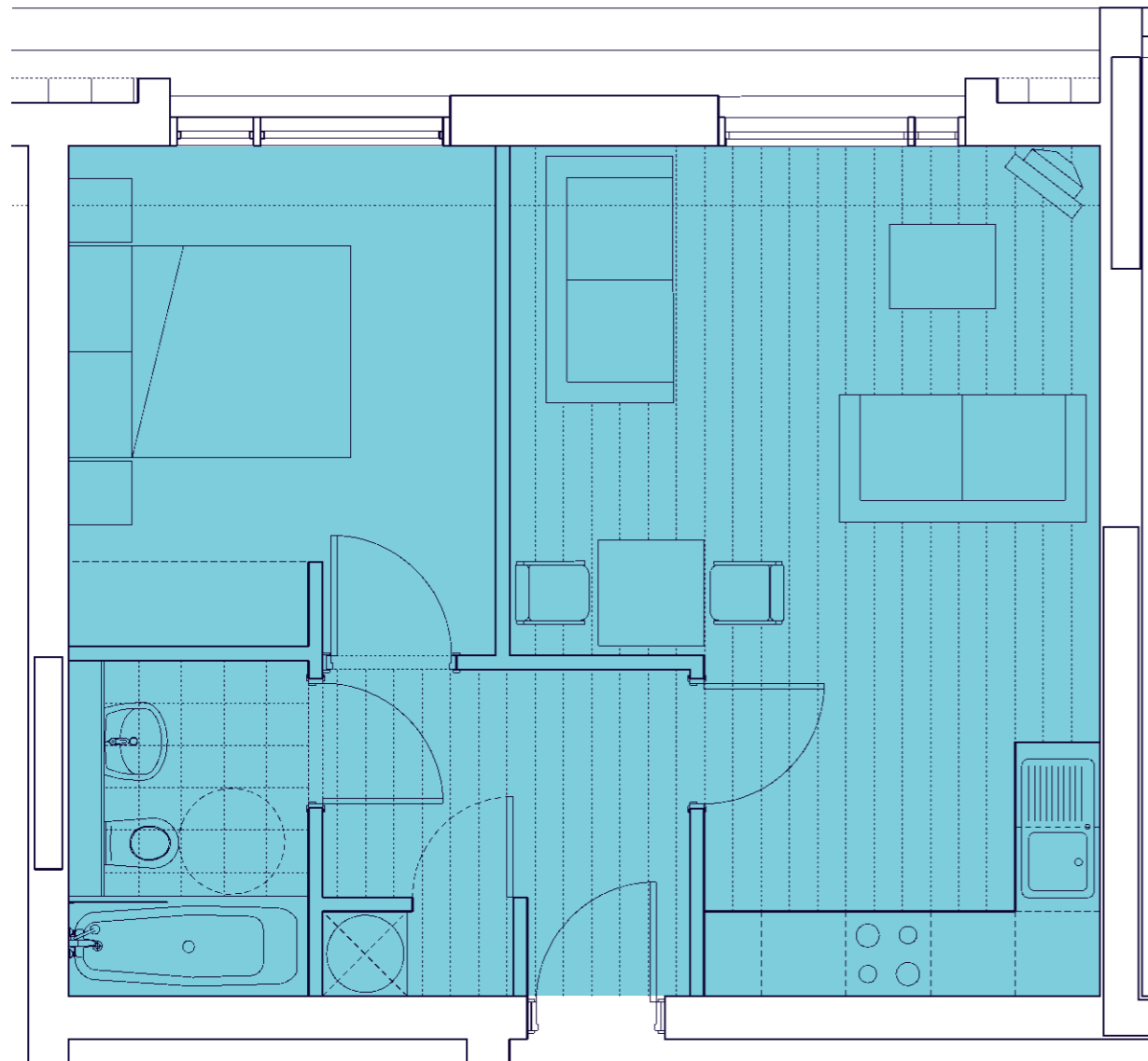

01

2 BF Bedroom, Type S  
Total = 1

44 m<sup>2</sup>  
1:50

1st Floor

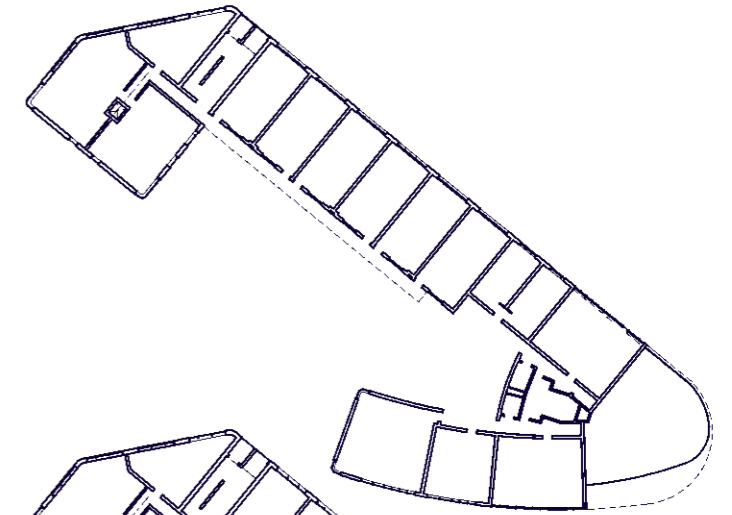

2nd to 4th Floor

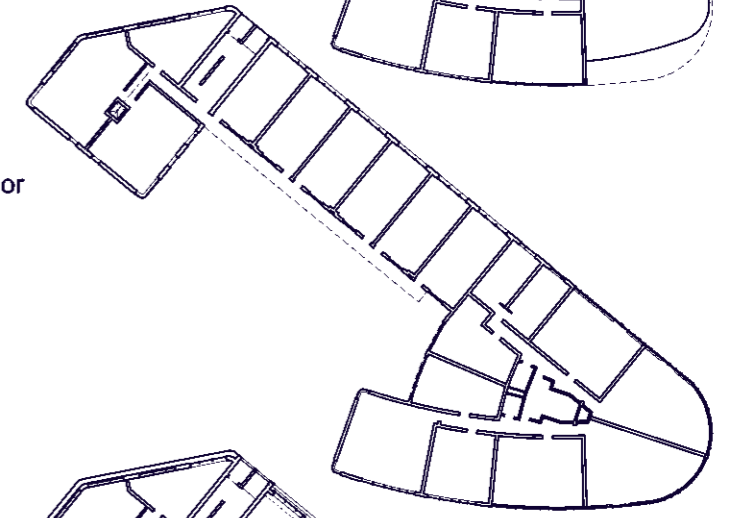

5th Floor

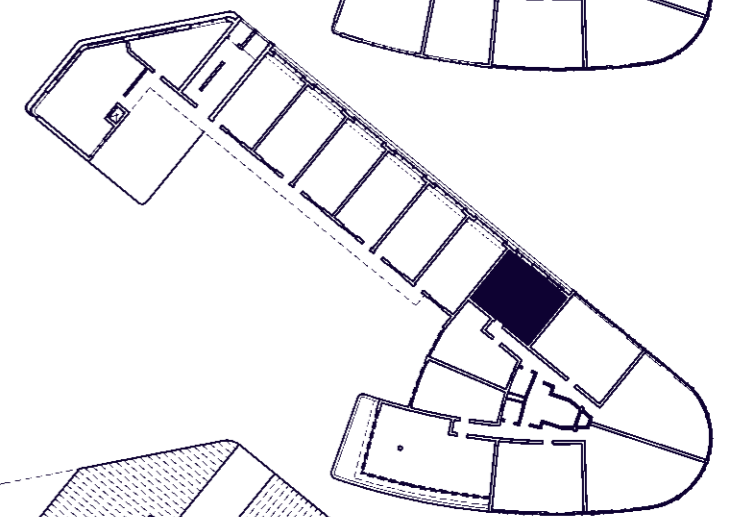

6th to 15th Floor

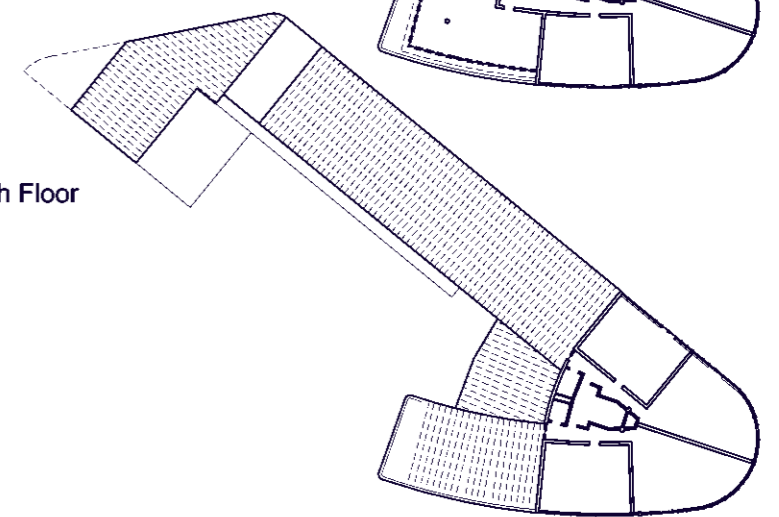



5th Floor C501  
 5th Floor C502  
 5th Floor C503  
 5th Floor C504  
 5th Floor C505  
 5th Floor C506

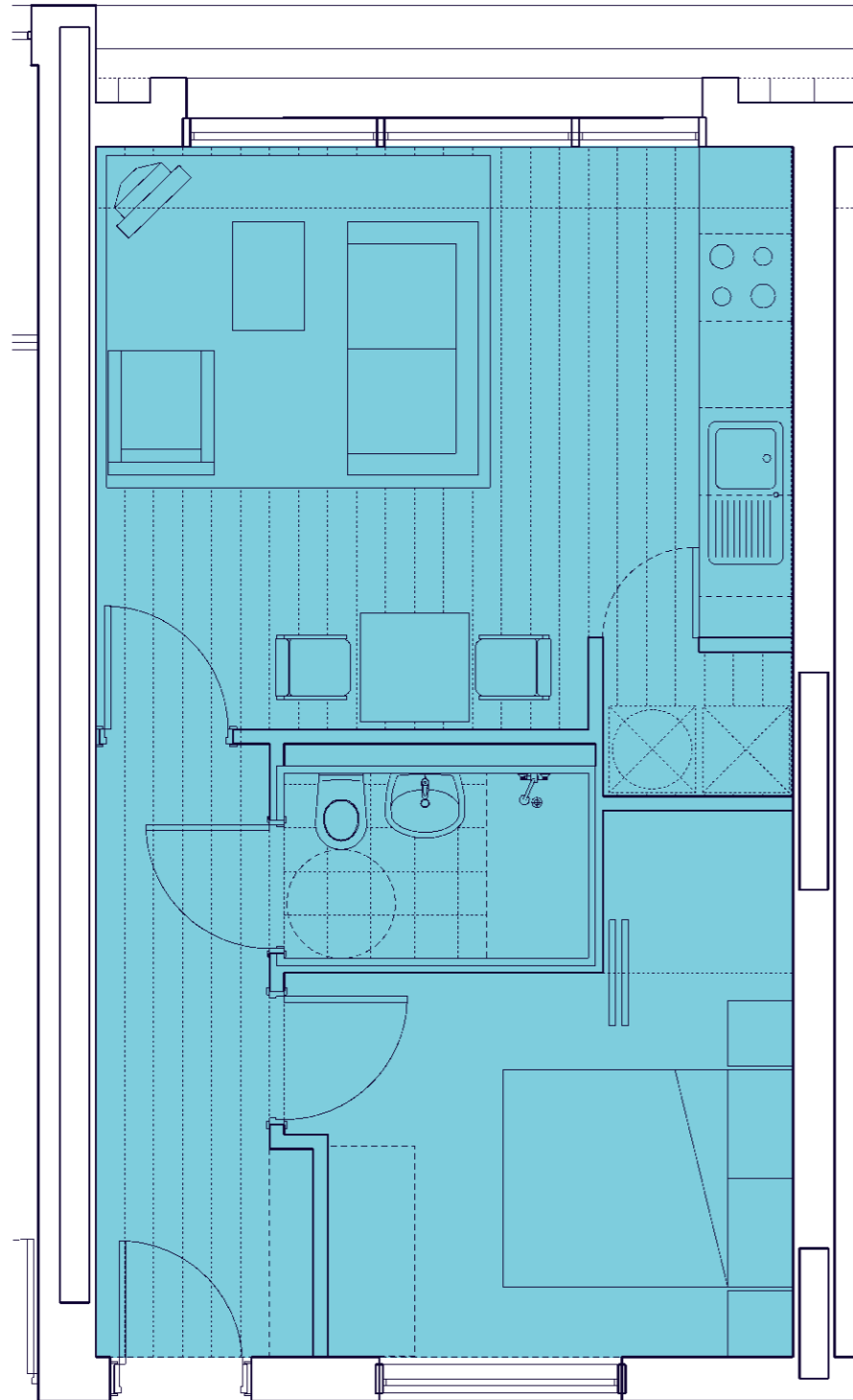

1st Floor

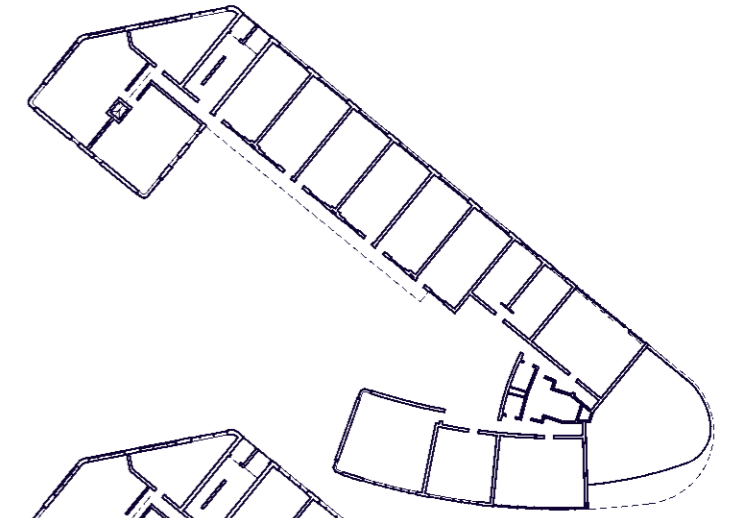

2nd to 4th Floor

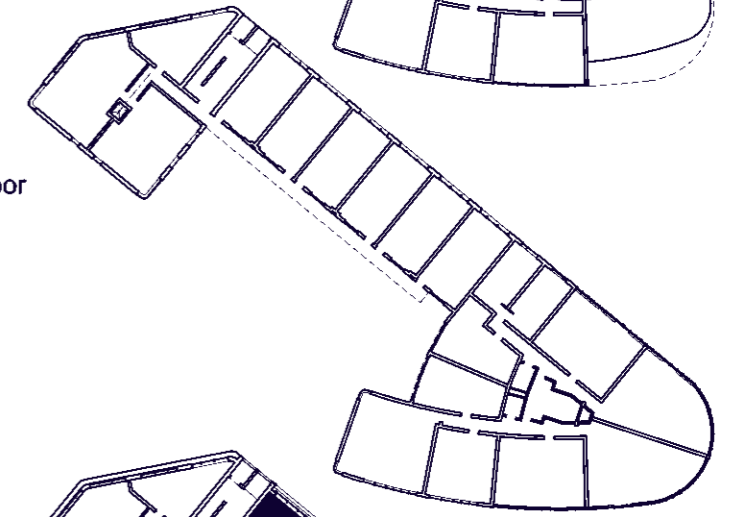

5th Floor

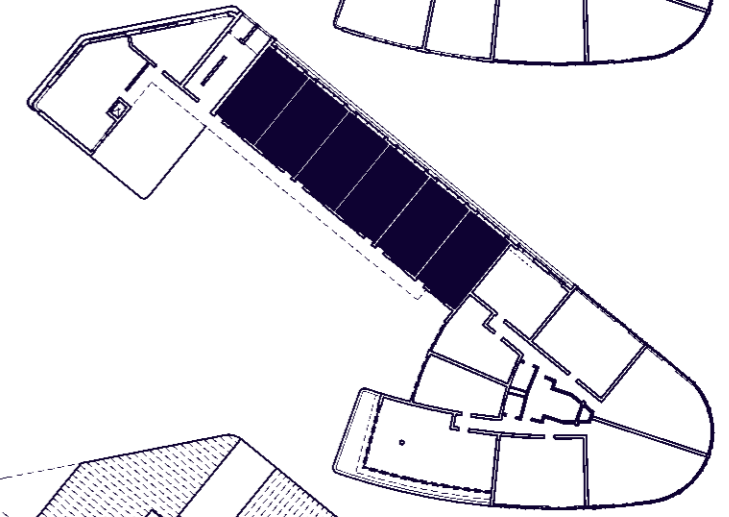

6th to 15th Floor

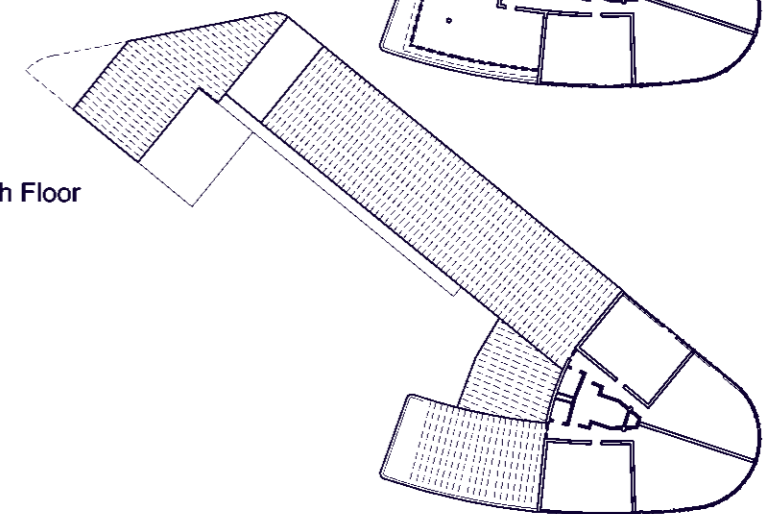

01

1 BF Bedroom, Type R  
 Total =6

40 m2  
 1:50

5th Floor C507

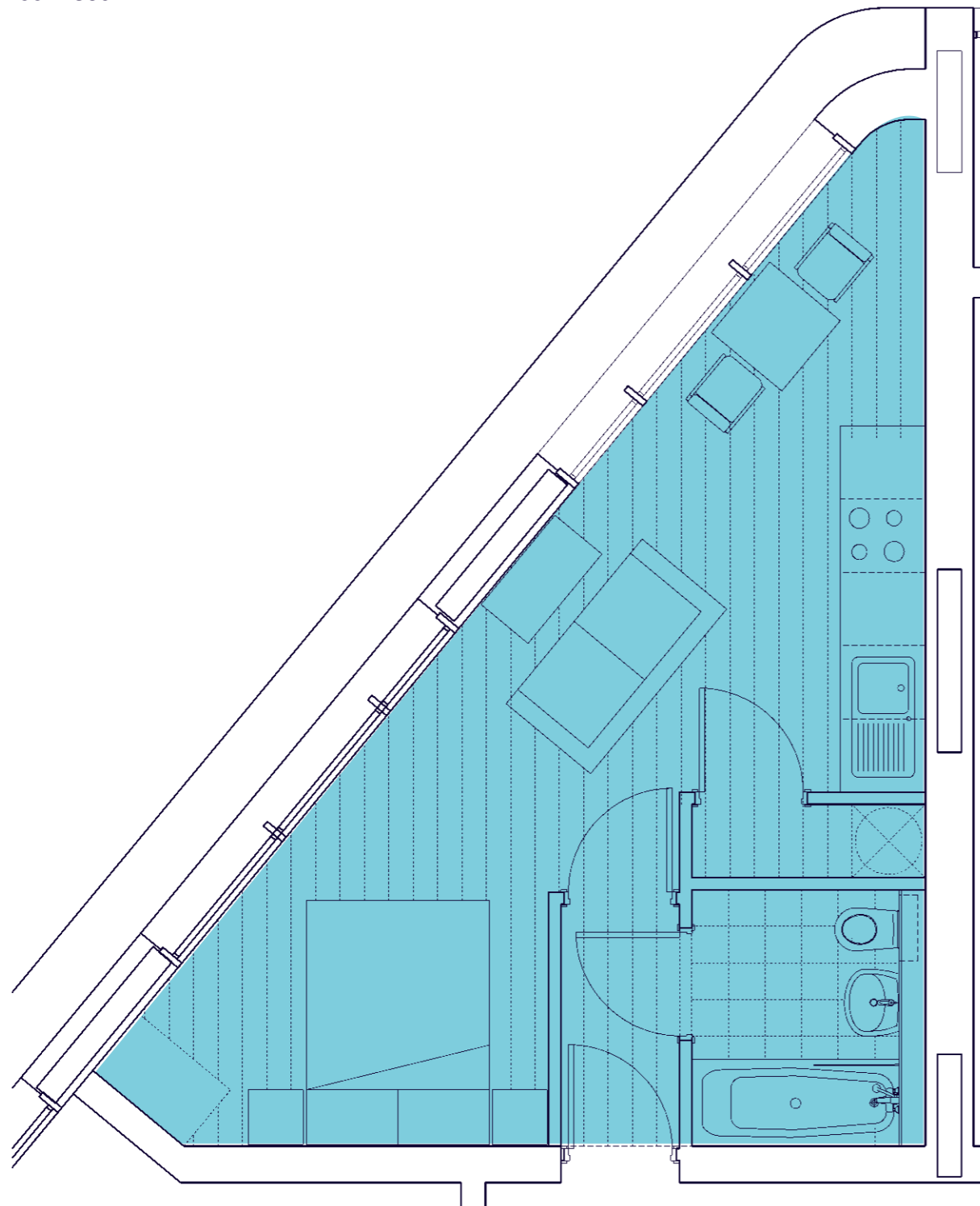

01

1 BF Bedroom, Type M  
Total =1

32 m2  
1:50

1st Floor

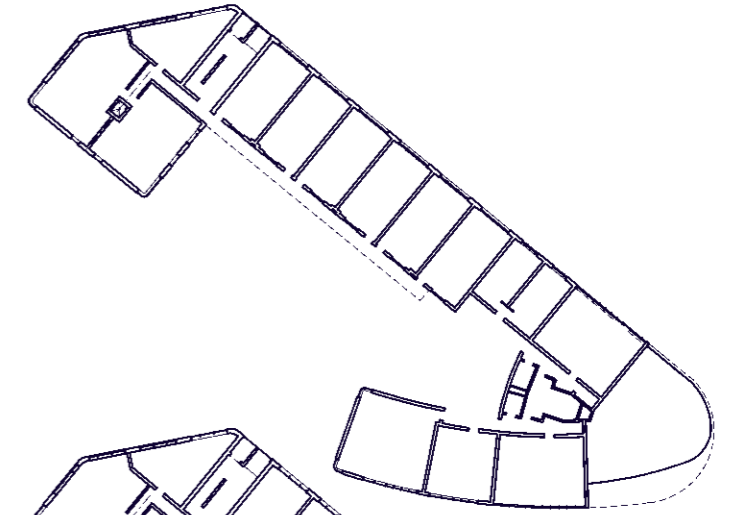

2nd to 4th Floor

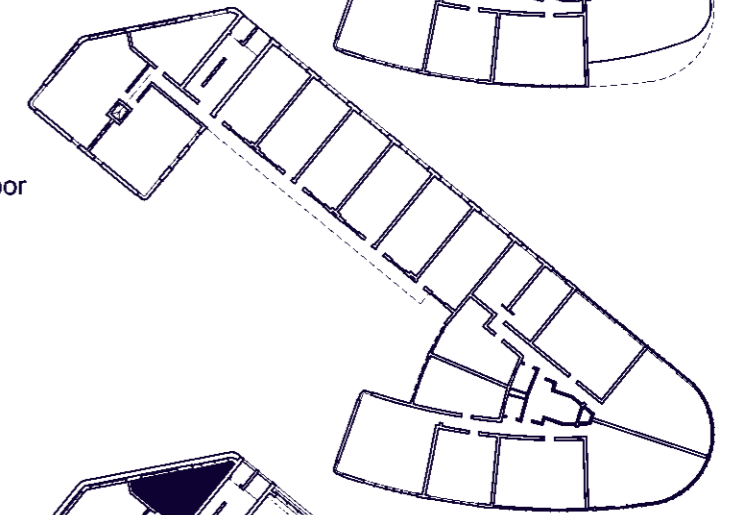

5th Floor

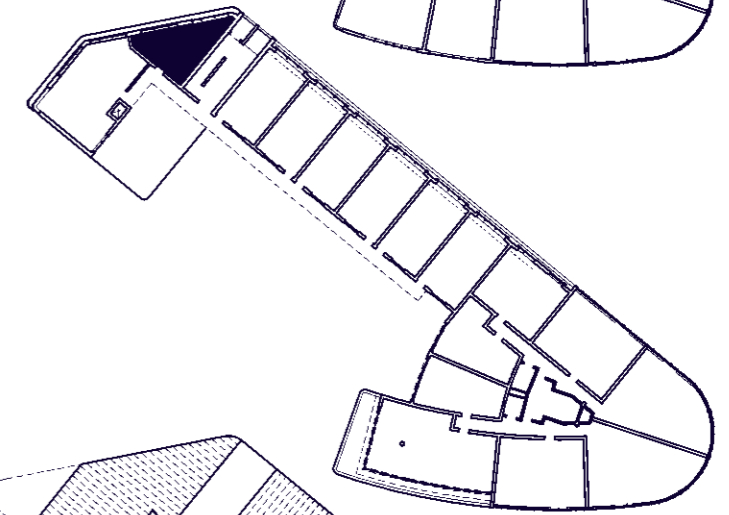

6th to 15th Floor

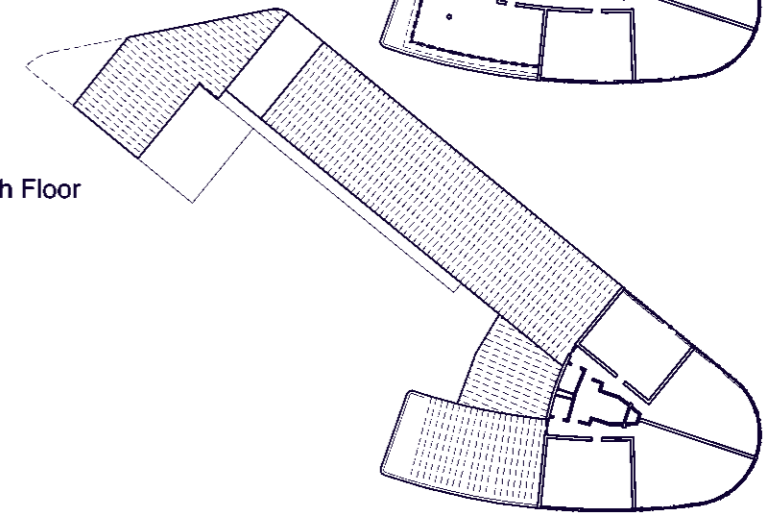

5th Floor C508

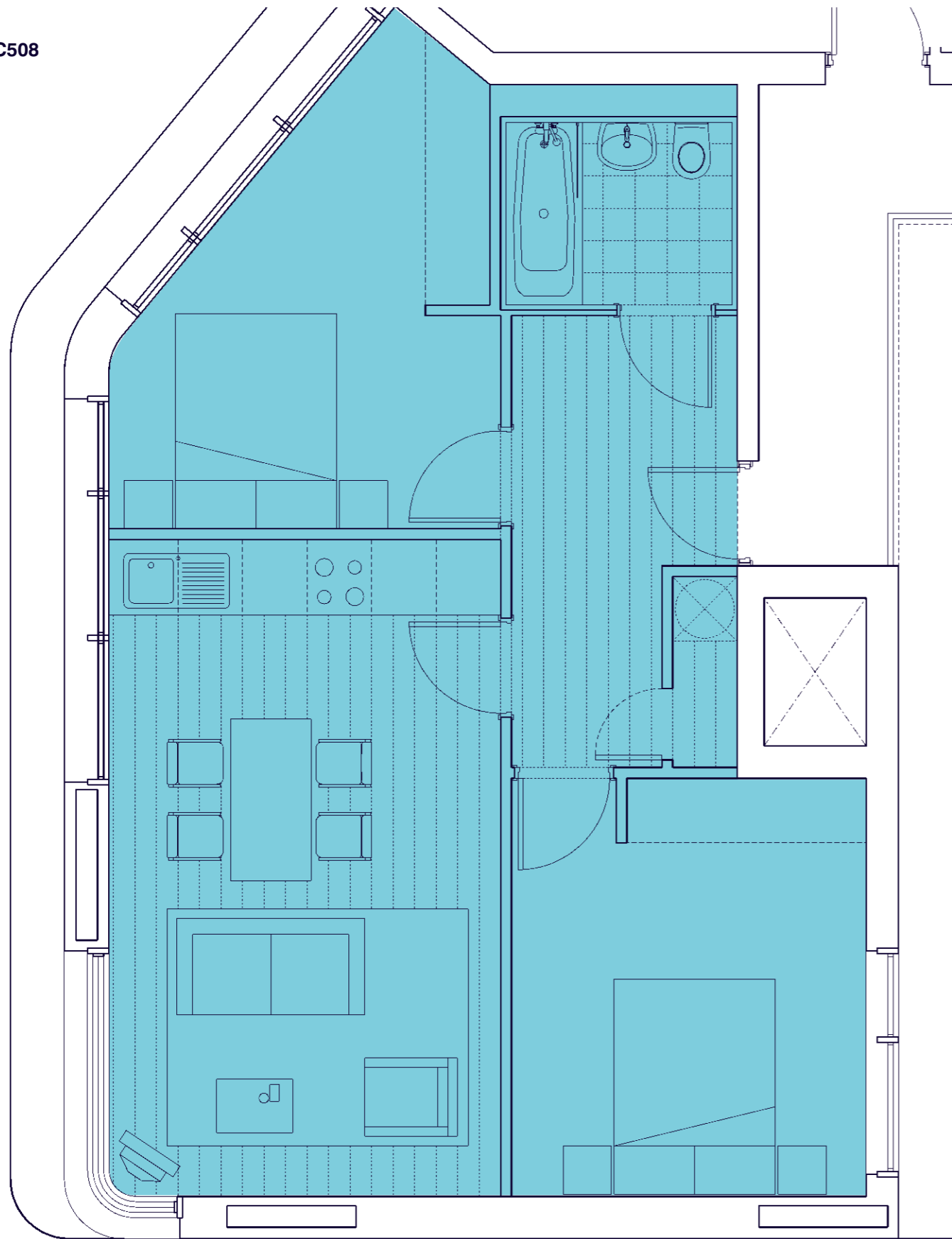

01

2 BF Bedroom, Type P  
Total = 1

63 m<sup>2</sup>  
1:50

1st Floor

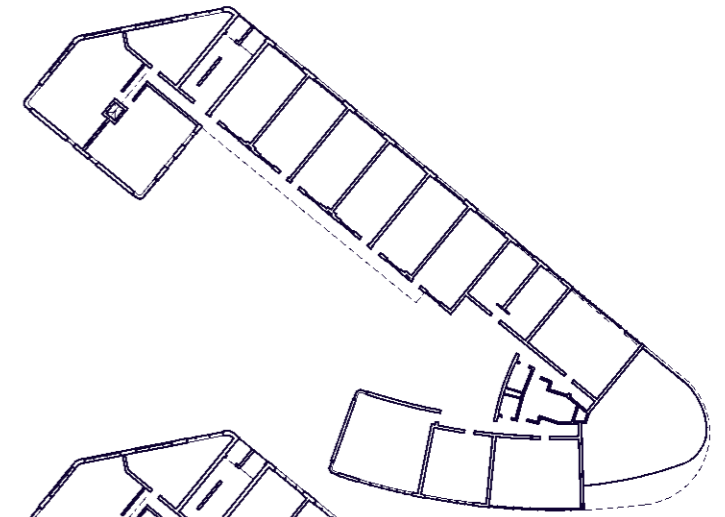

2nd to 4th Floor

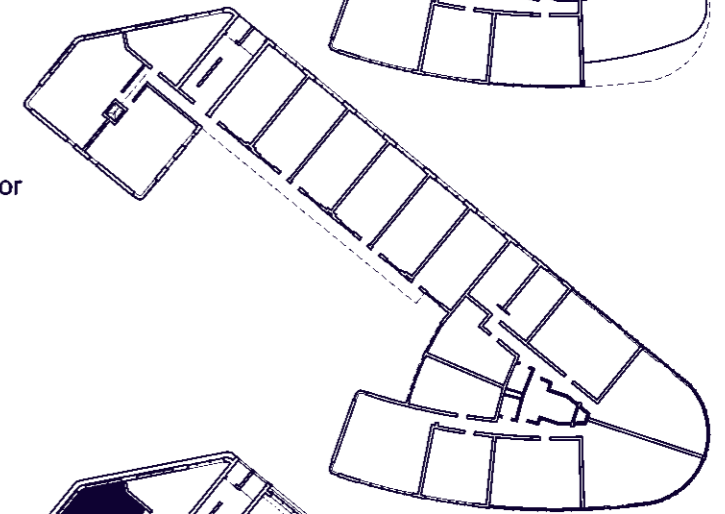

5th Floor

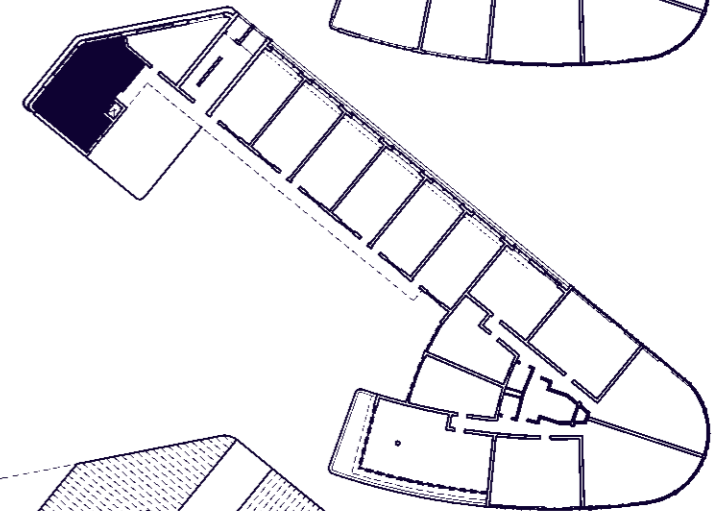

6th to 15th Floor

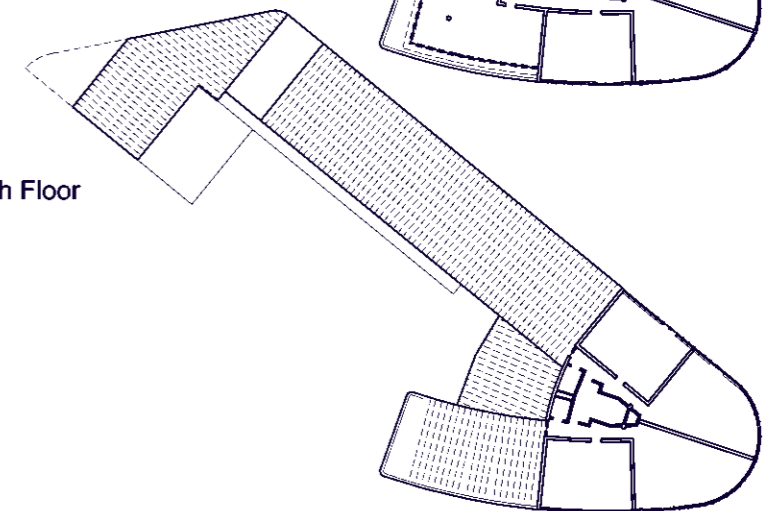

3rd Floor B308  
4th Floor B408  
5th Floor B508



6th to 15th Floor

1st Floor

2nd Floor

3rd to 4th Floor

5th Floor

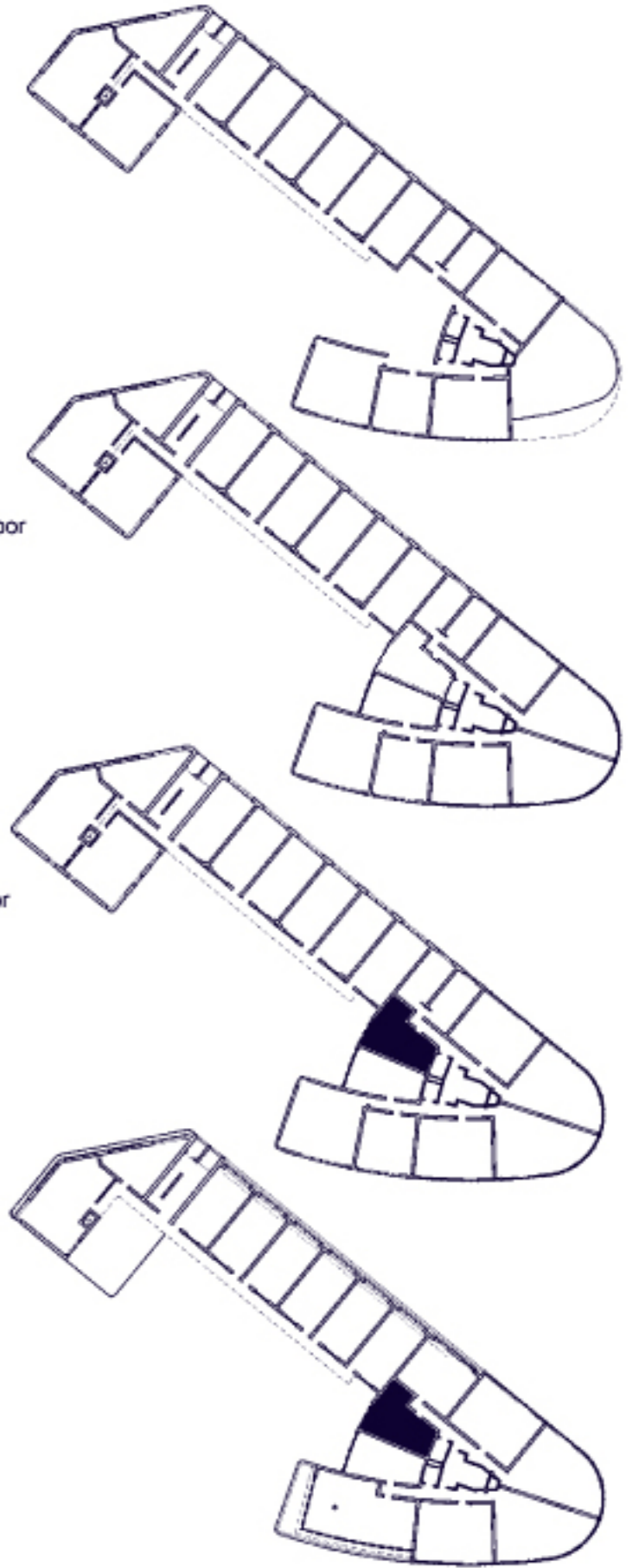

01

1 BF Studio, Type N  
Total = 3

36.5 m<sup>2</sup>  
1:50



3rd Floor B309  
4th Floor B409  
5th Floor B509

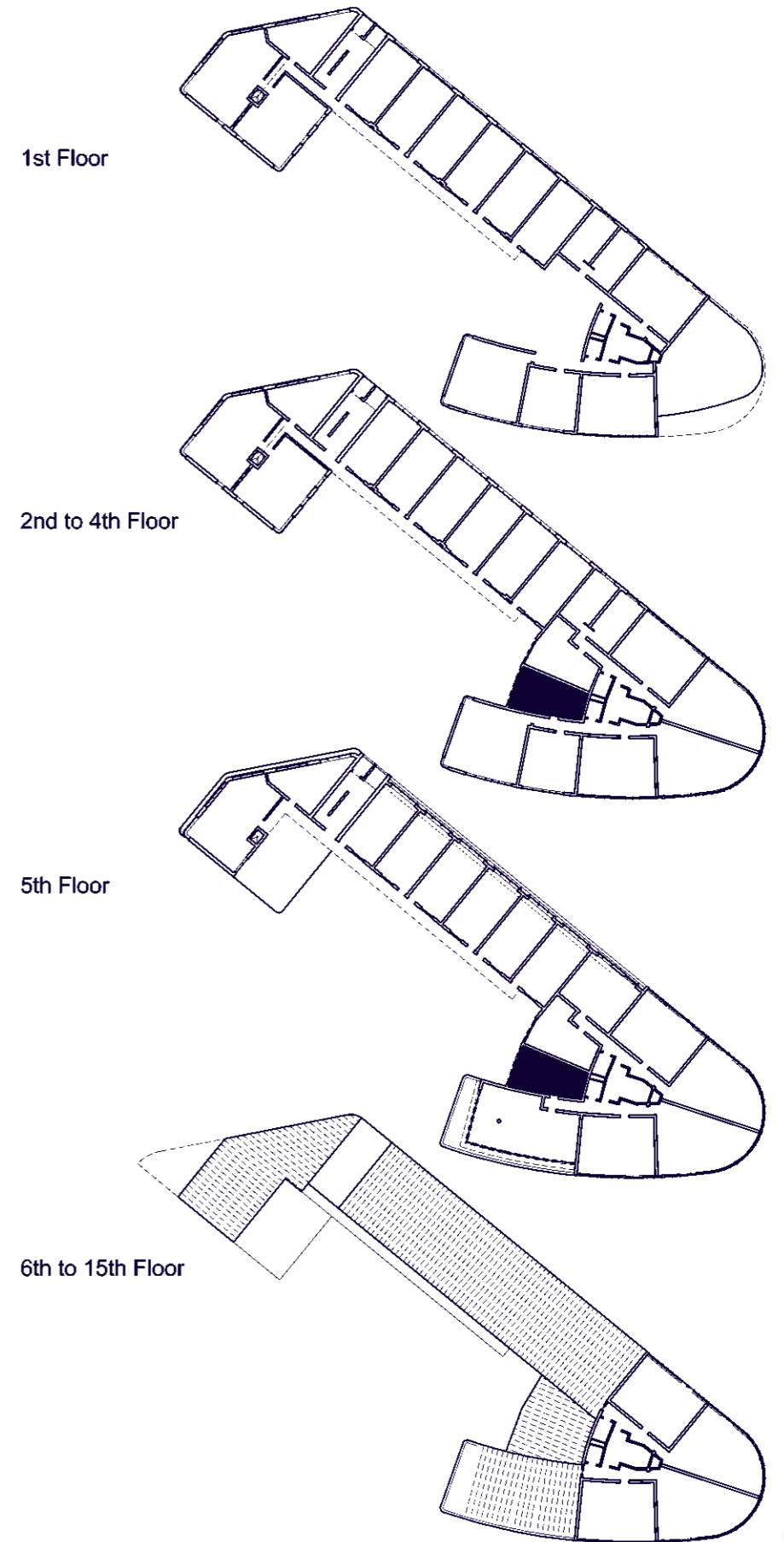

01

1 BF Studio, Type Q  
Total = 3

34.5 m<sup>2</sup>  
1:50

1st Floor B101  
2nd Floor B201  
3rd Floor B301  
4th Floor B401



01

2 BF Bedroom, Type L  
Total = 4

67 m<sup>2</sup>  
1:50

1st Floor

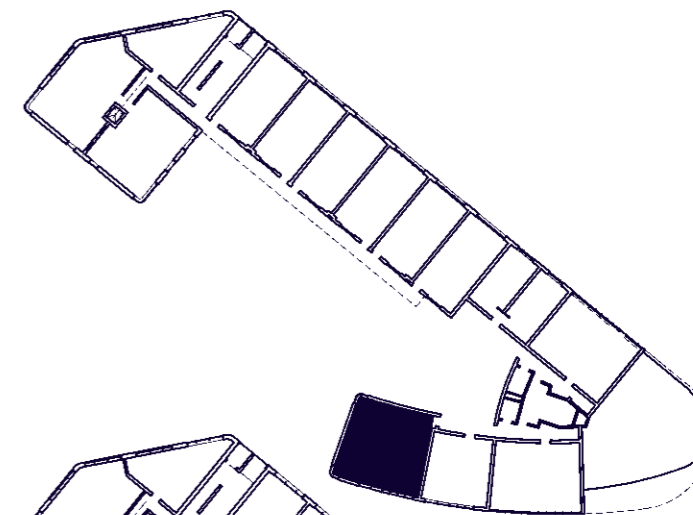

2nd to 4th Floor

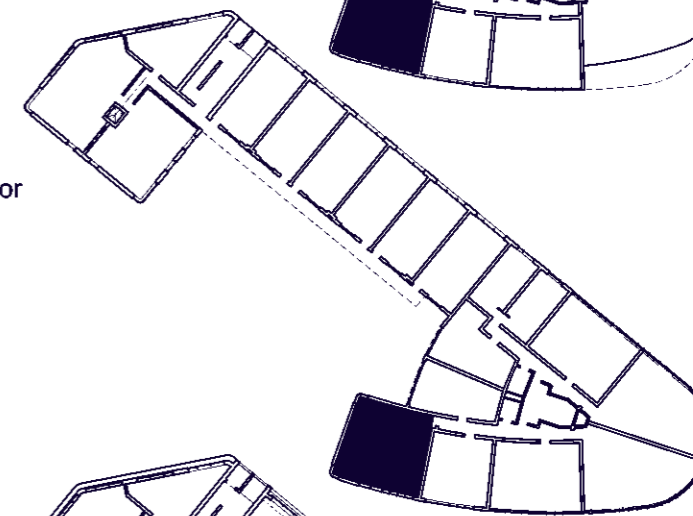

5th Floor

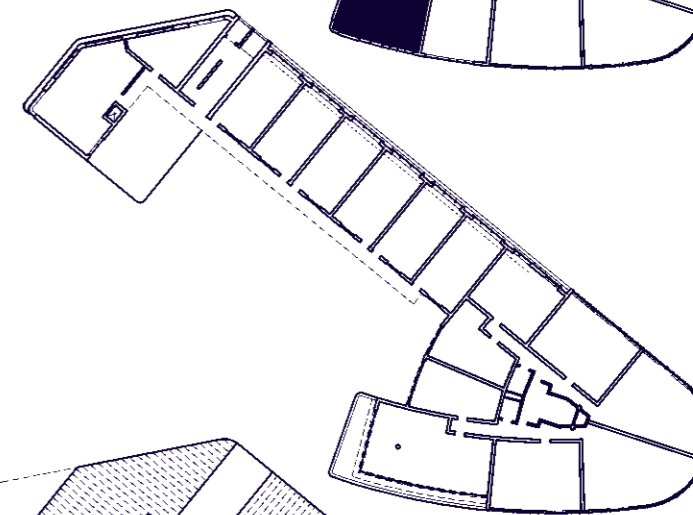

6th to 15th Floor

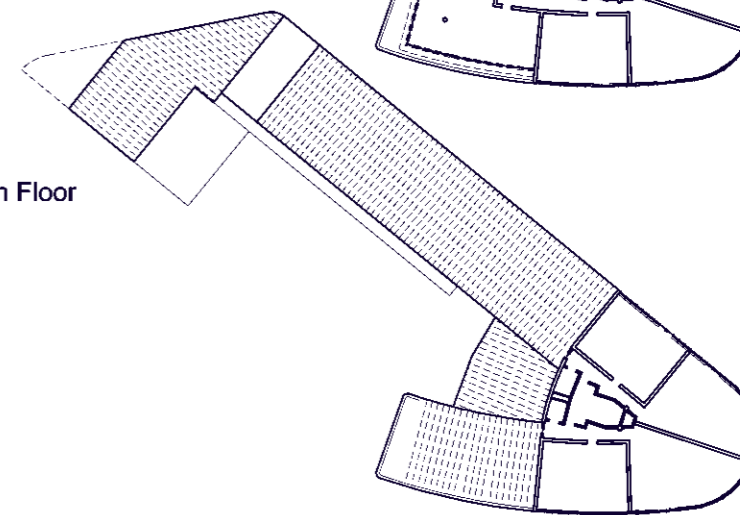

- 3rd Floor B305
- 4th Floor B405
- 5th Floor B505
- 6th Floor B605
- 7th Floor B705
- 8th Floor B805
- 9th Floor B905
- 10th Floor B1005
- 11th Floor B1105
- 12th Floor B1205
- 13th Floor B1305
- 14th Floor B1405
- 15th Floor B1505

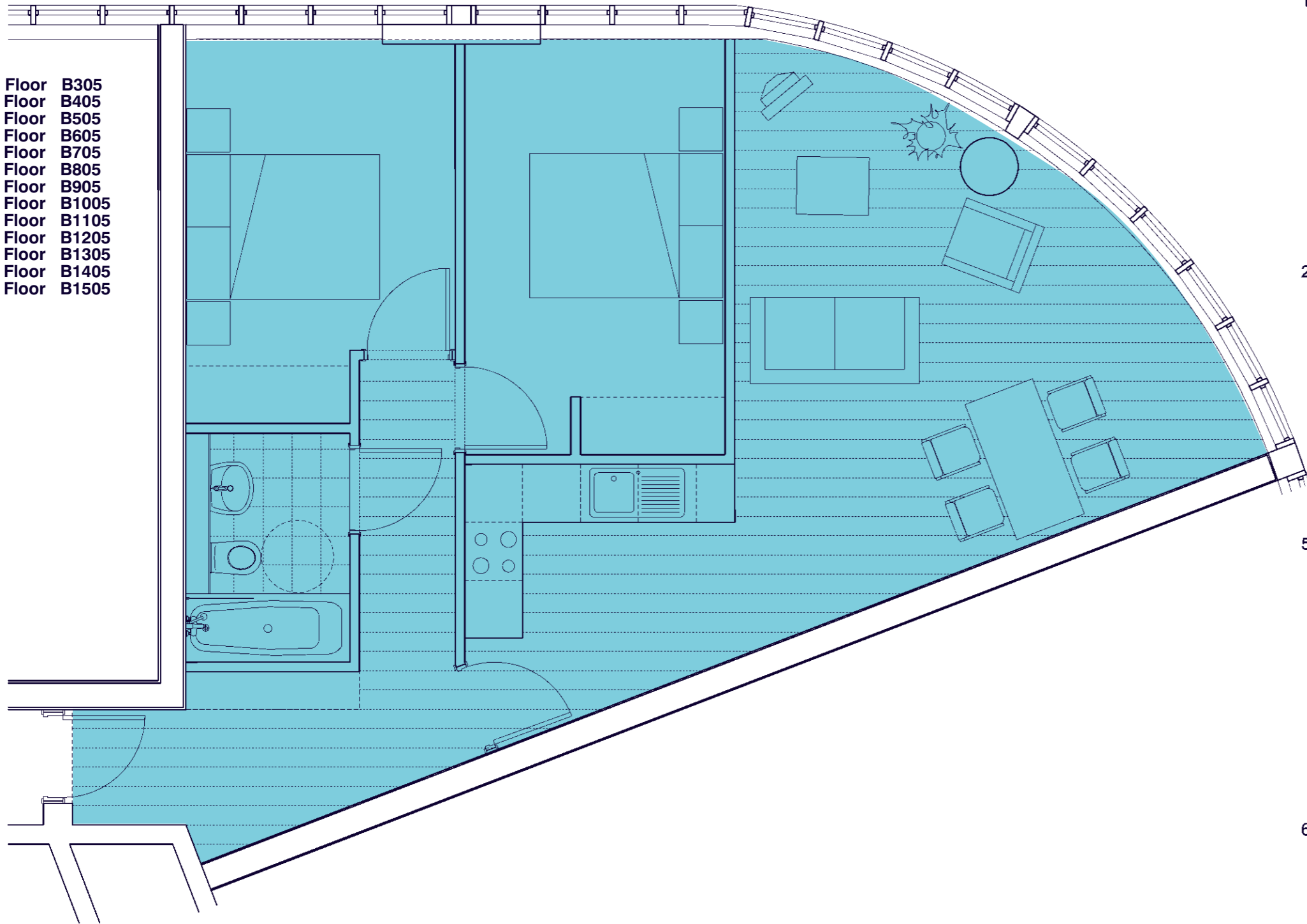

1st Floor

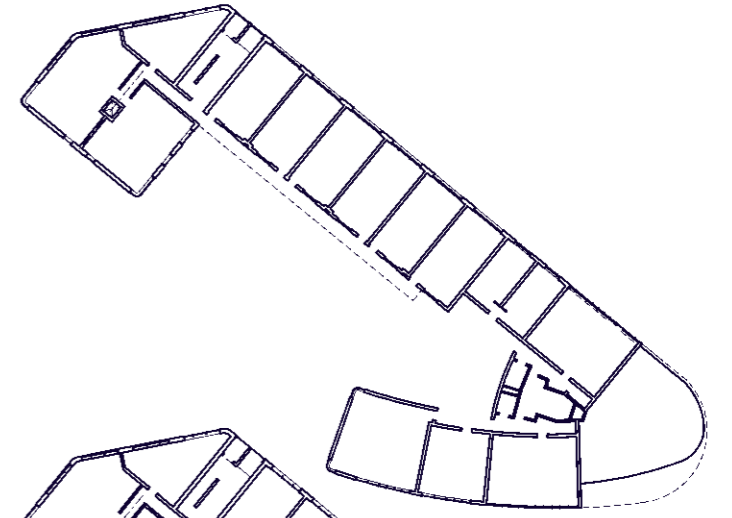

2nd to 4th Floor

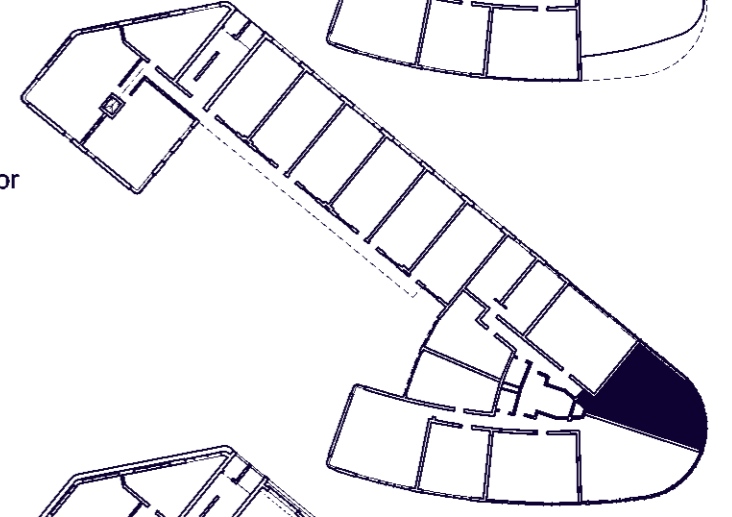

5th Floor

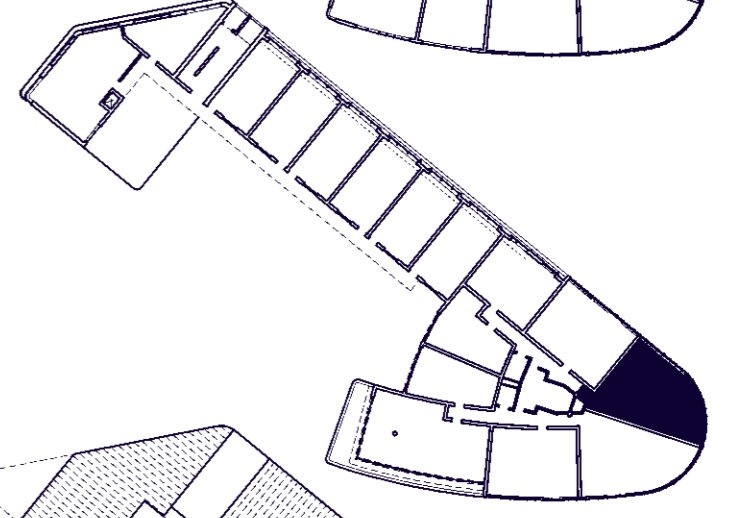

6th to 15th Floor

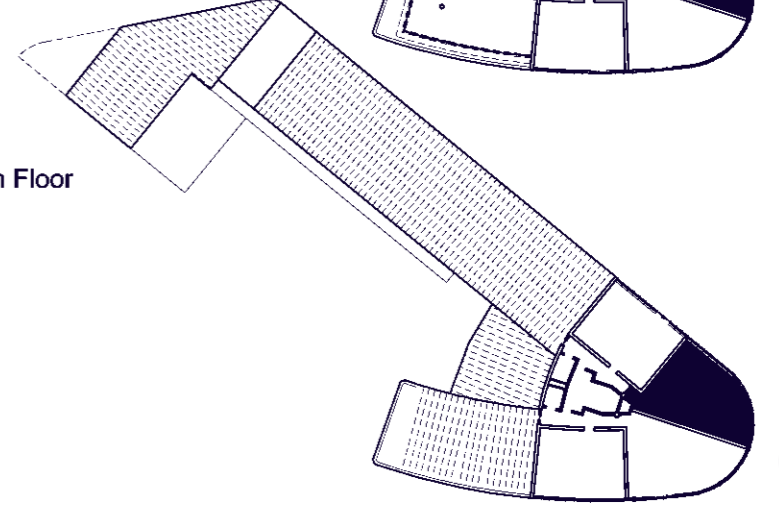

01

2 BF Bedroom, Type G  
Total = 13

68.5 m2  
1:50

1st Floor B102  
2nd Floor B202  
3rd Floor B302  
4th Floor B402

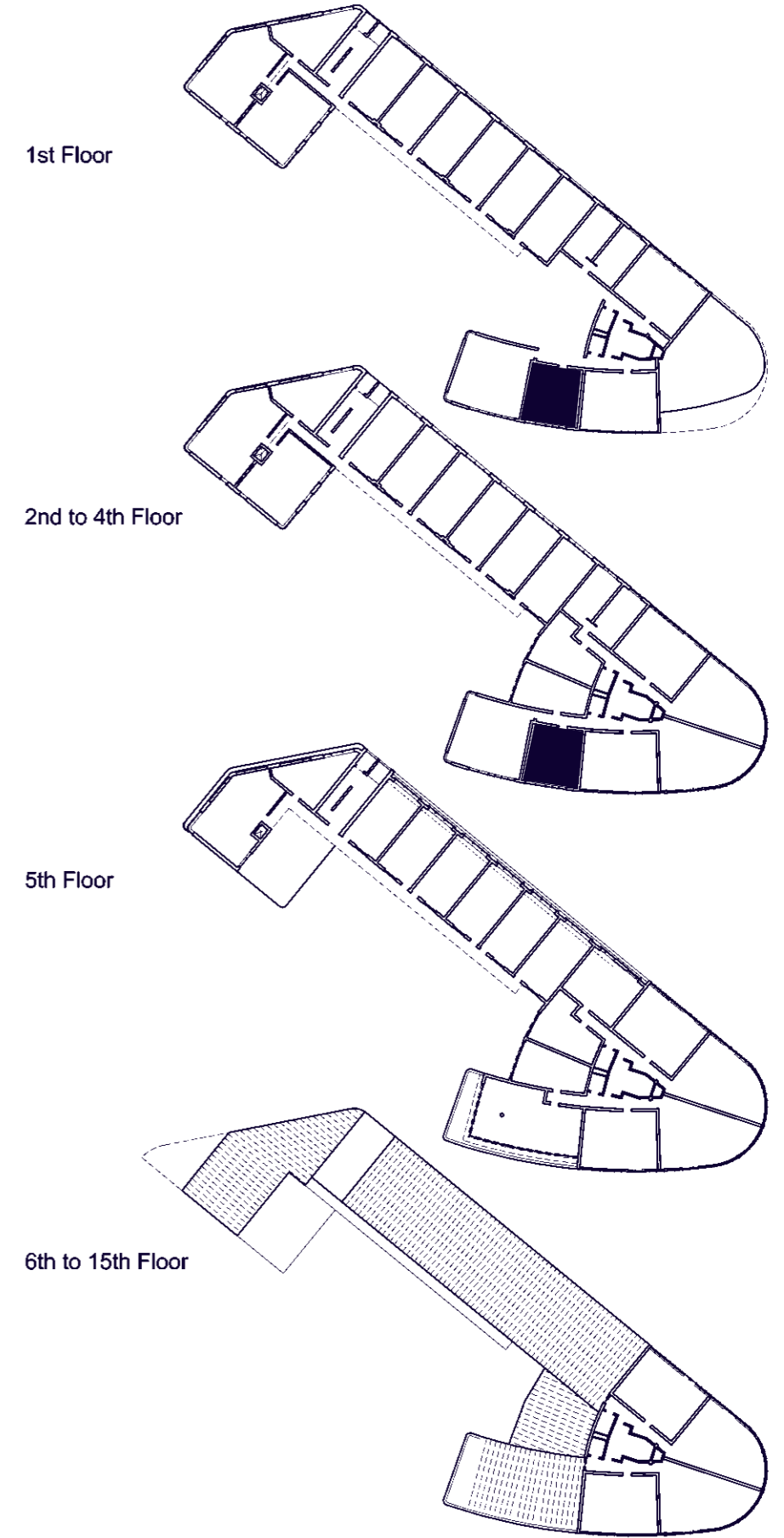

01

1 BF Bedroom, Type K  
Total = 4

41 m<sup>2</sup>  
1:50



- 2nd Floor B203
- 3rd Floor B303
- 4th Floor B403
- 5th Floor B503
- 6th Floor B603
- 7th Floor B703
- 8th Floor B803
- 9th Floor B903
- 10th Floor B1003
- 11th Floor B1103
- 12th Floor B1203
- 13th Floor B1303
- 14th Floor B1403
- 15th Floor B1503



1st Floor

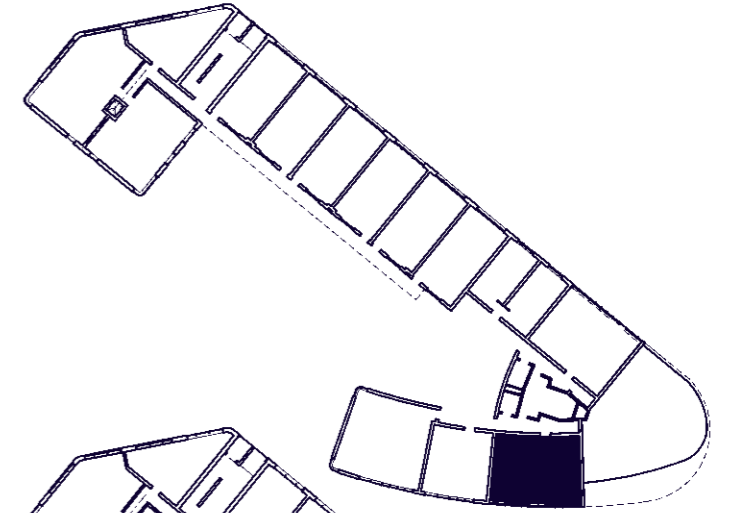

2nd to 4th Floor

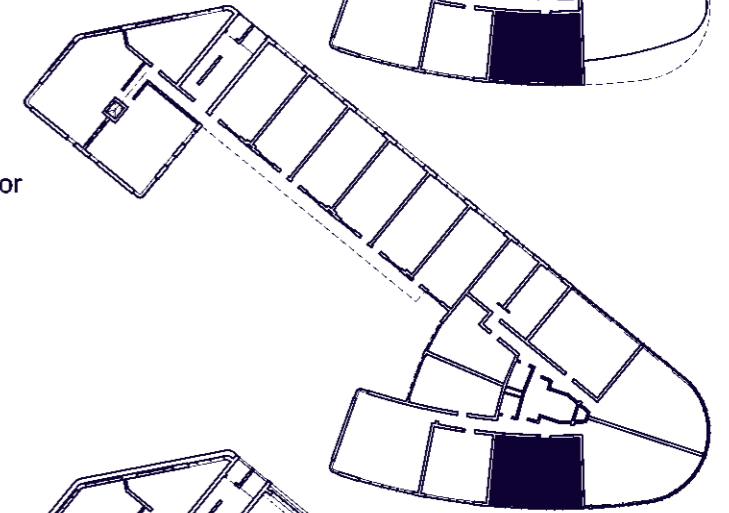

5th Floor

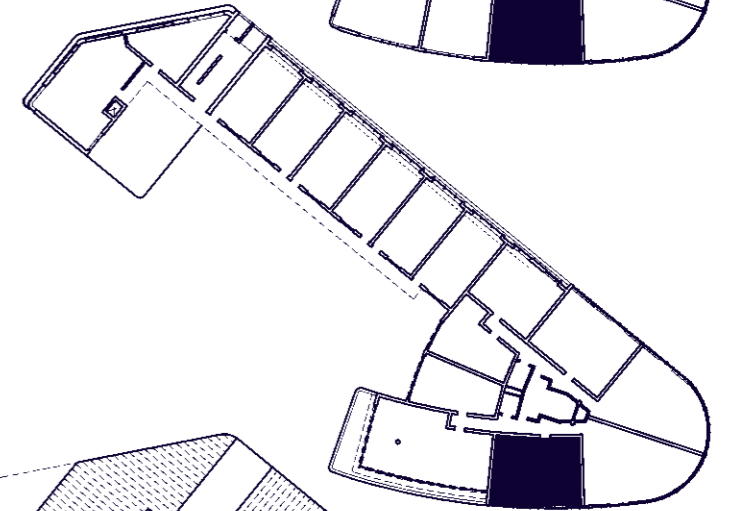

6th to 15th Floor

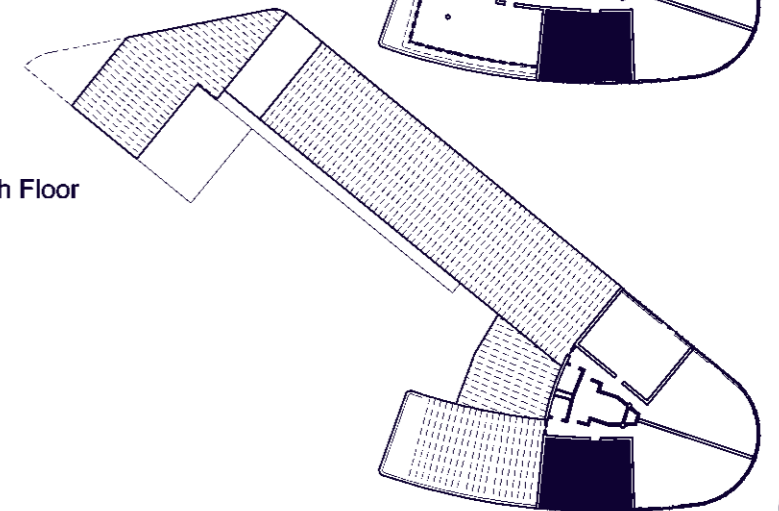

01

2 BF Bedroom, Type J  
Total = 14

57 m2  
1:50

- 3rd Floor B304
- 4th Floor B404
- 5th Floor B504
- 6th Floor B604
- 7th Floor B704
- 8th Floor B804
- 9th Floor B904
- 10th Floor B1004
- 11th Floor B1104
- 12th Floor B1204
- 13th Floor B1304
- 14th Floor B1404
- 15th Floor B1504



01

2 BF Bedroom, Type H  
Total =13

69 m<sup>2</sup>  
1:50

1st Floor

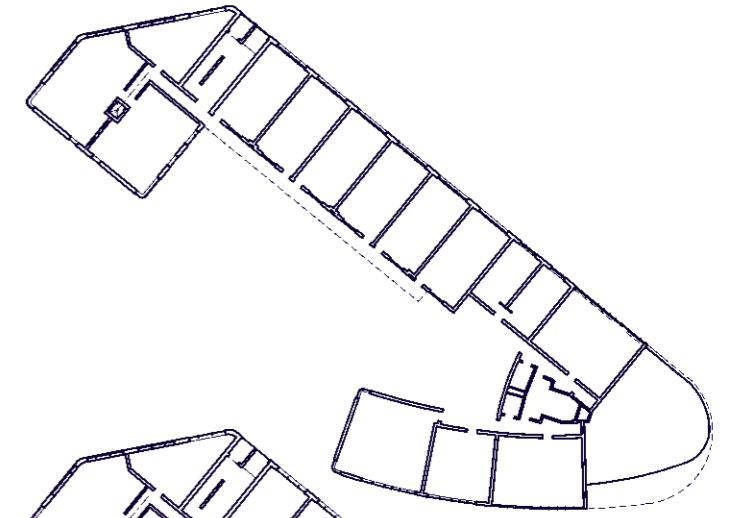

2nd to 4th Floor

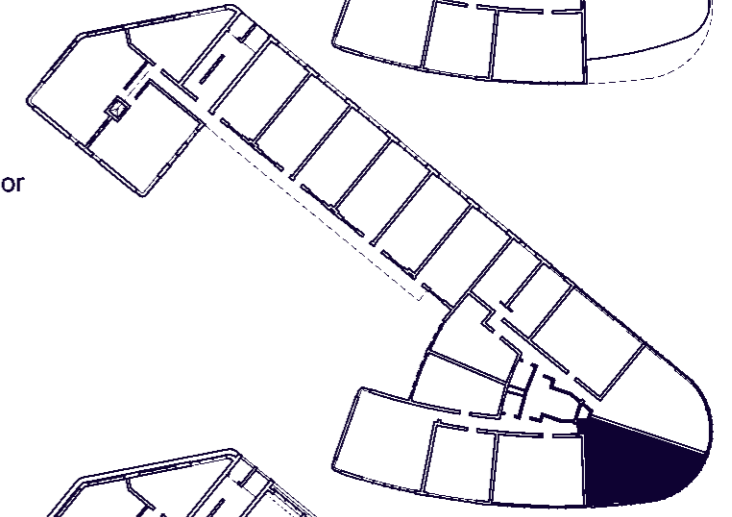

5th Floor

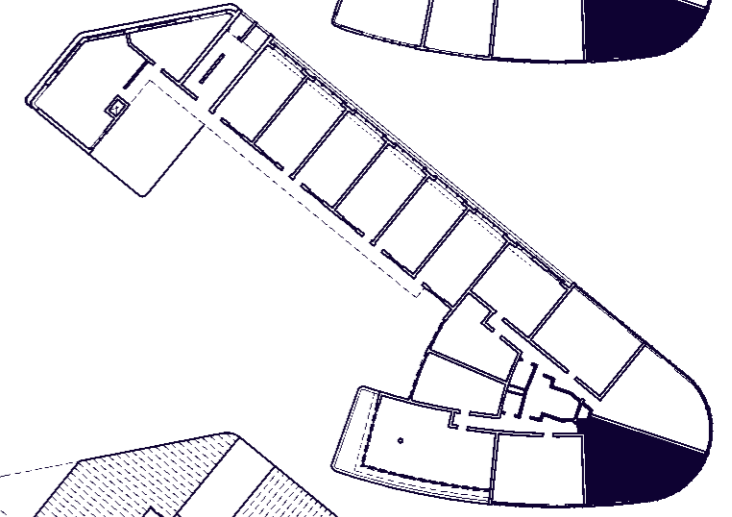

6th to 15th Floor

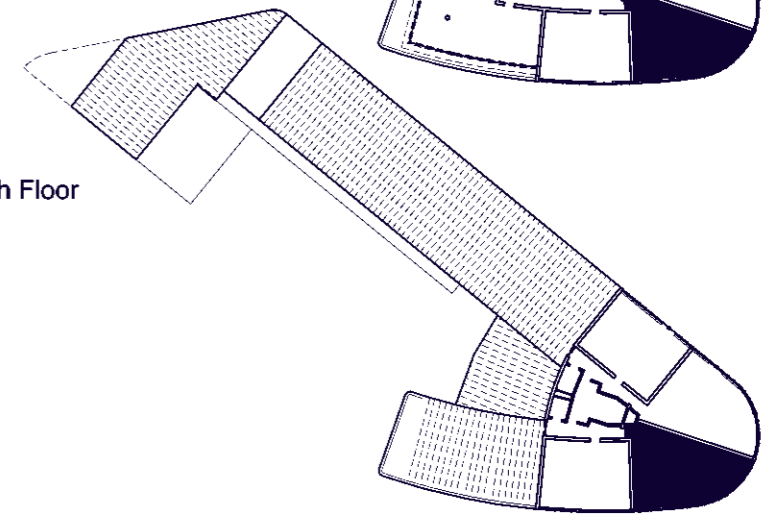

- 1st Floor C101
- 1st Floor C102
- 1st Floor C103
- 1st Floor C104
- 1st Floor C105
- 1st Floor C106
- 2nd Floor C201
- 2nd Floor C202
- 2nd Floor C203
- 2nd Floor C204
- 2nd Floor C205
- 2nd Floor C206
- 3rd Floor C301
- 3rd Floor C302
- 3rd Floor C303
- 3rd Floor C304
- 3rd Floor C305
- 3rd Floor C306
- 4th Floor C401
- 4th Floor C402
- 4th Floor C403
- 4th Floor C404
- 4th Floor C405
- 4th Floor C406

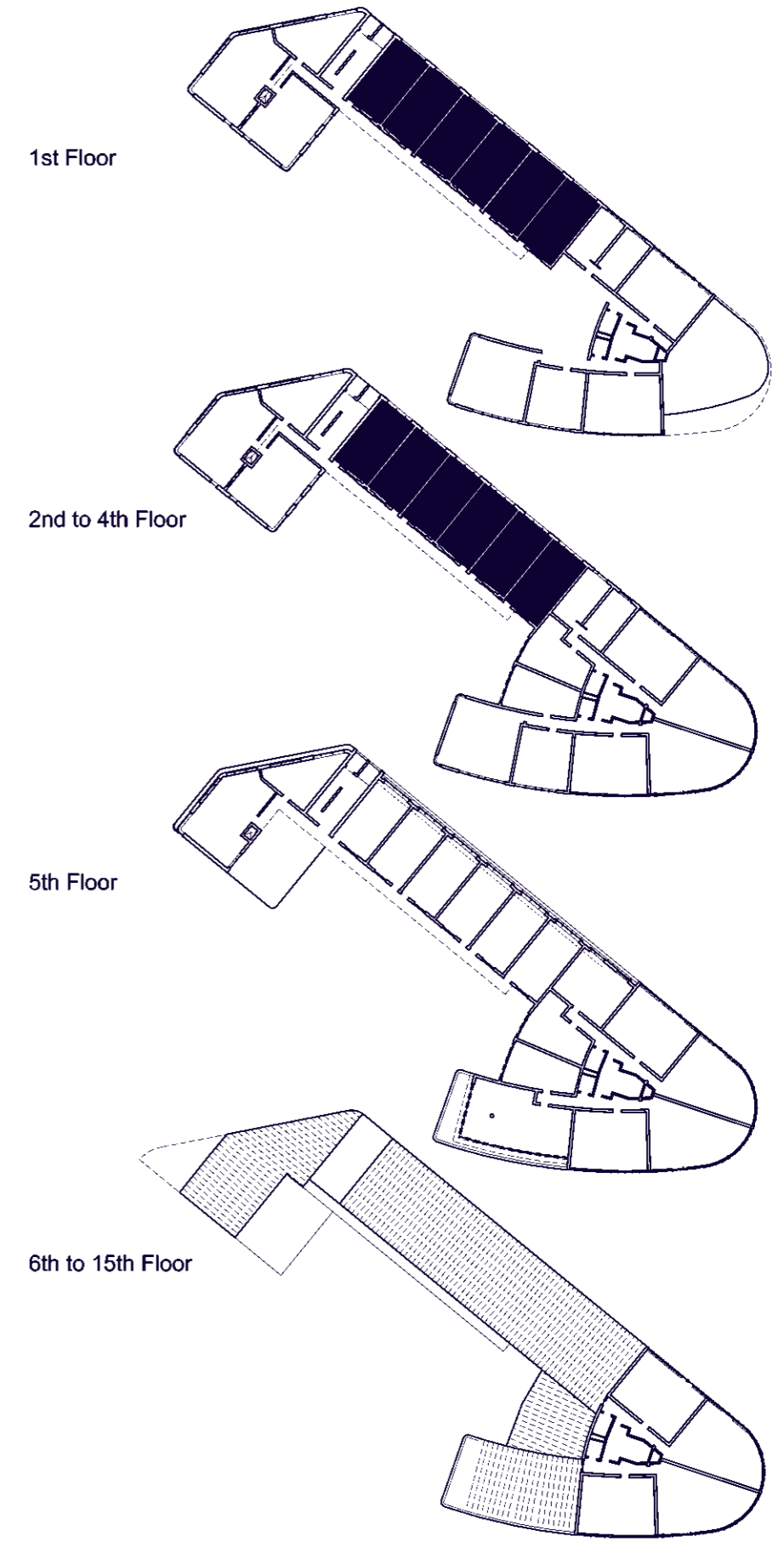
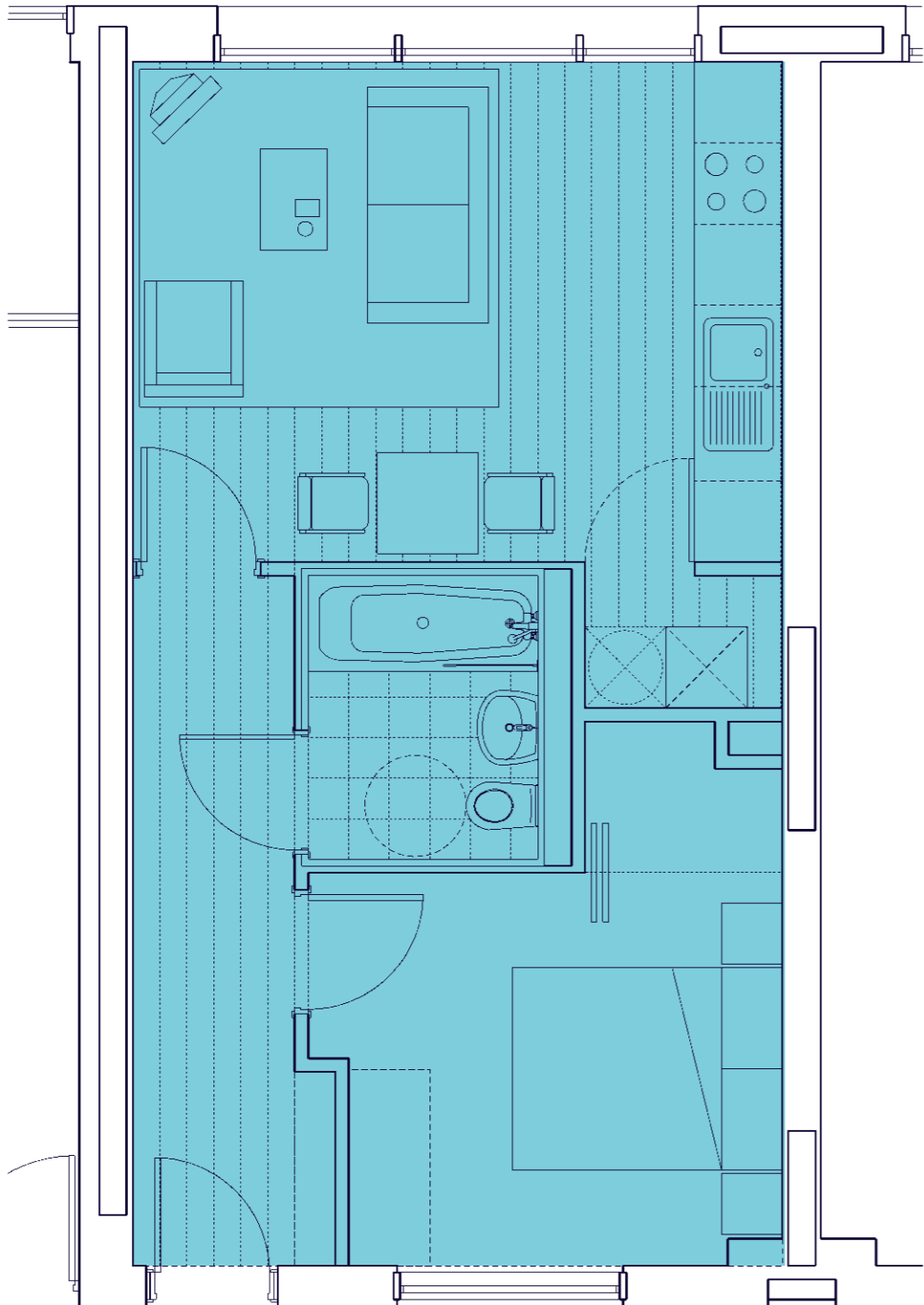

01

1 BF Bedroom, Type D  
Total =24

43 m<sup>2</sup>  
1:50

# Penthouse 120

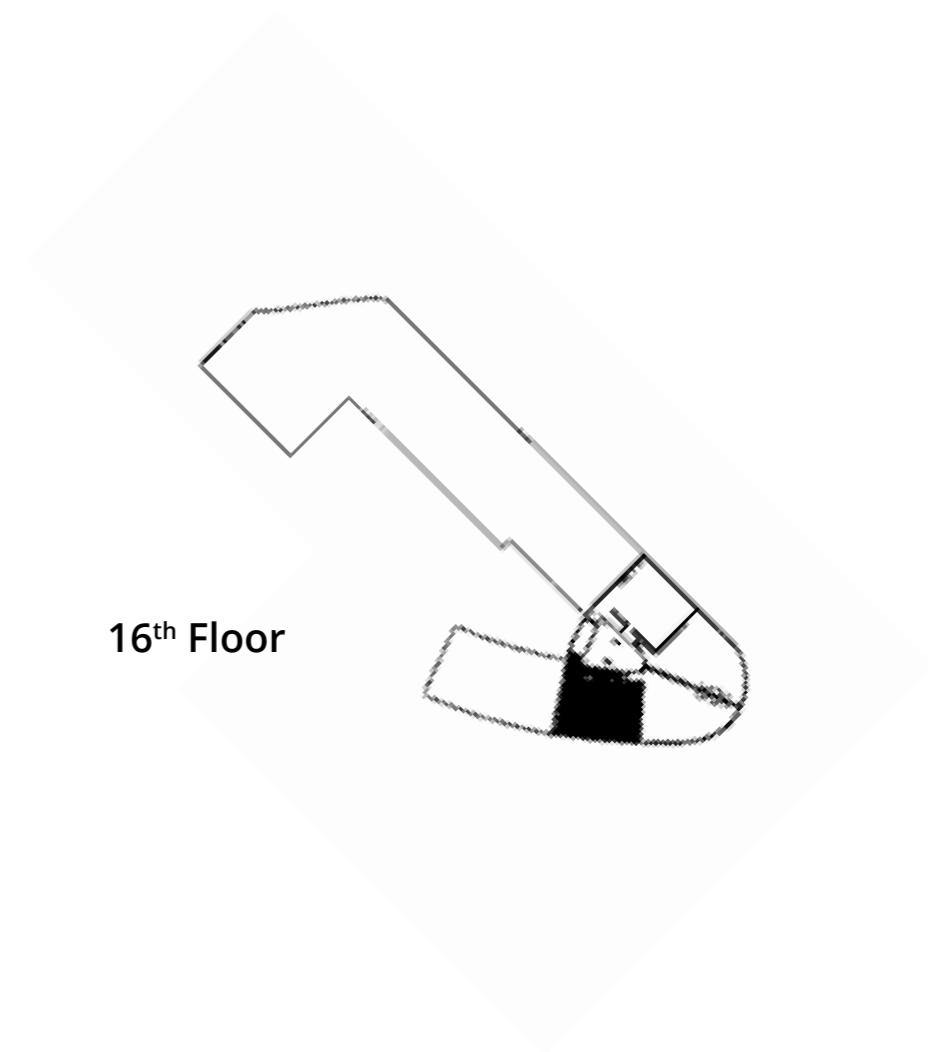
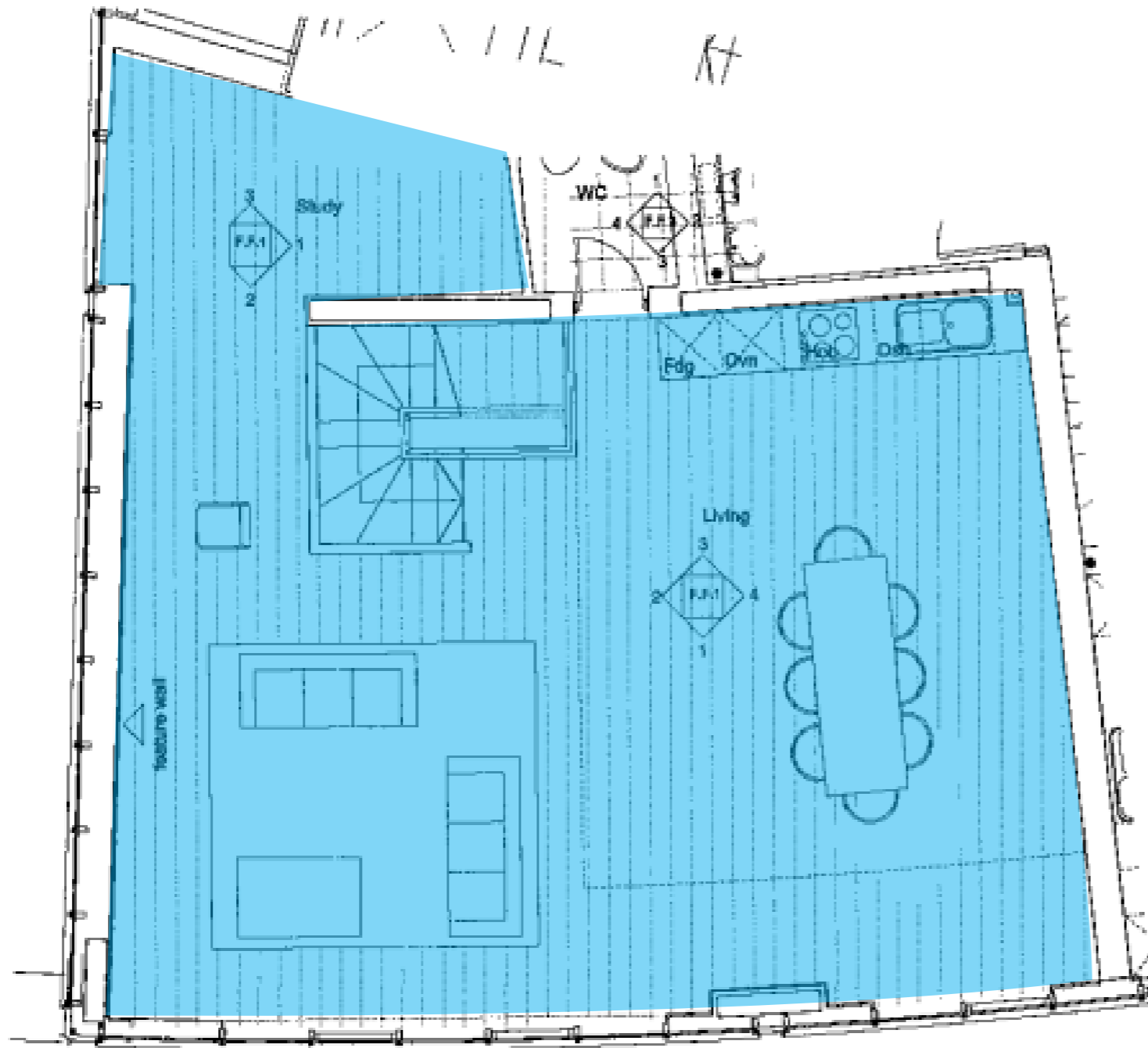

01

3 Bedroom, Type X  
Total = 1

61 m<sup>2</sup>  
1:50



# Penthouse 122

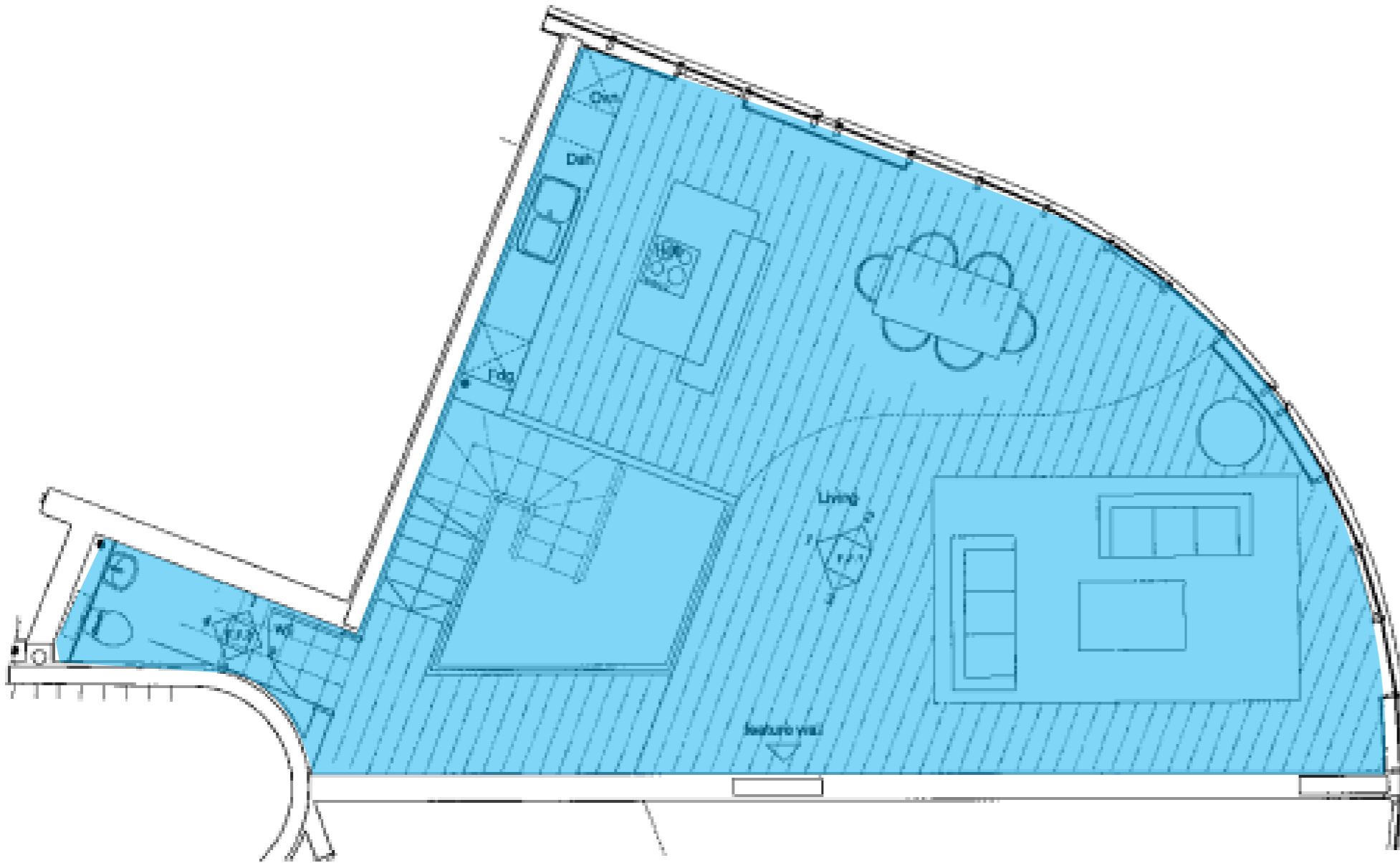

16<sup>th</sup> Floor

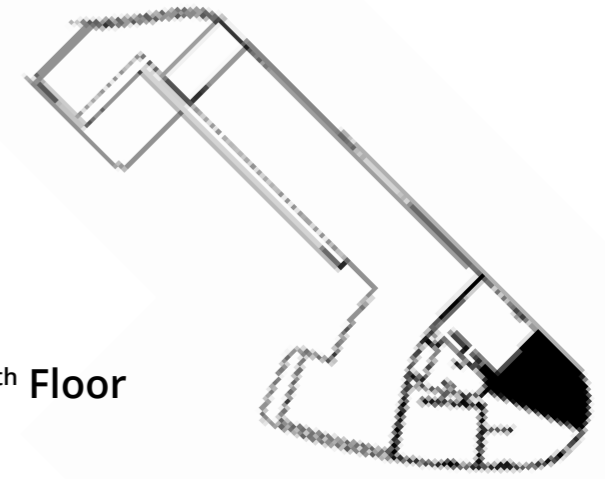

01

3 Bedroom, Type V  
Total = 2

69 m<sup>2</sup>  
1:50

One beds Ground floor

1A

1B

1C

1D

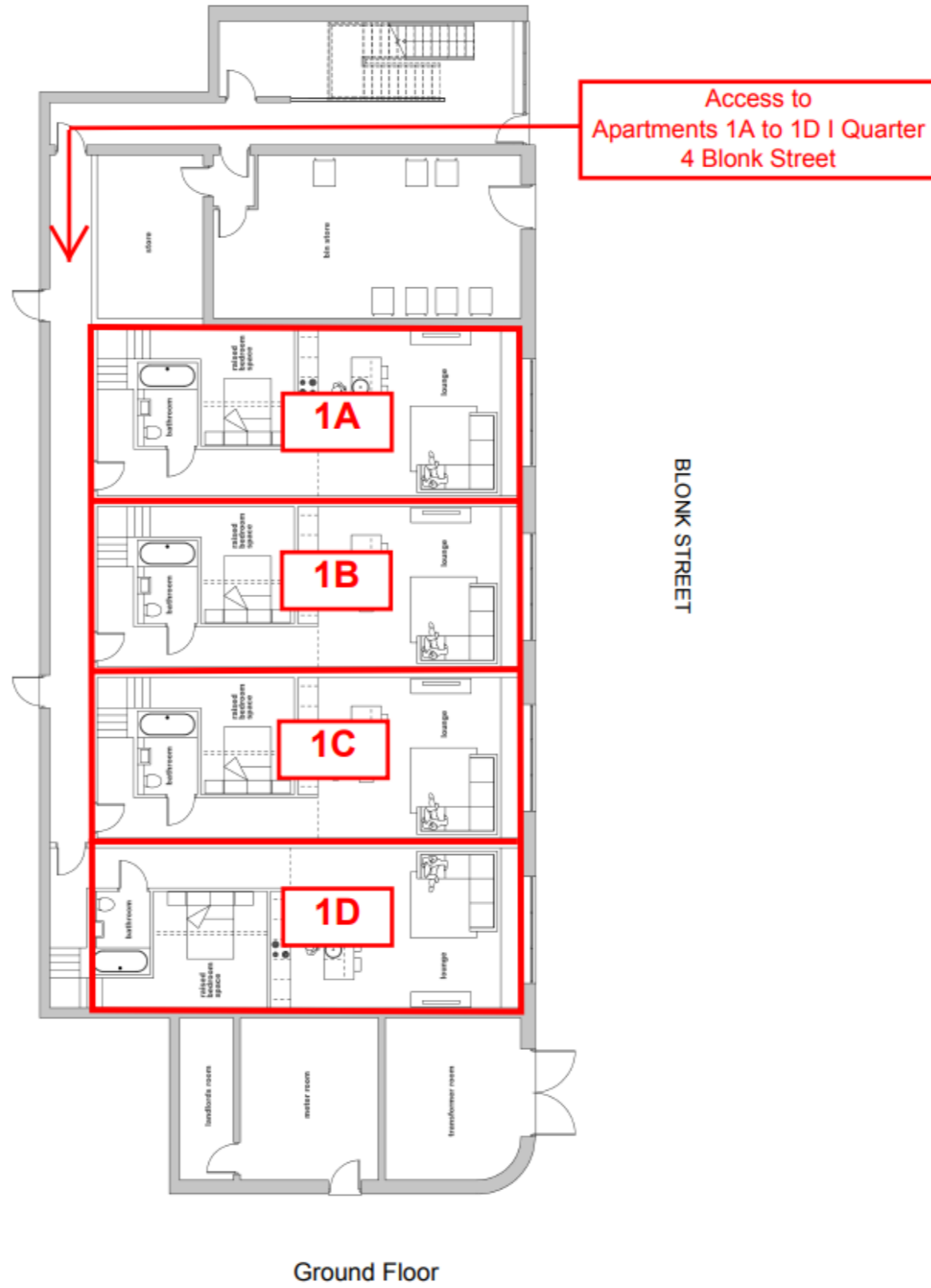



Ground Floor Level		
A001 - A3/A4/B1 Retail/food and drink	240 m <sup>2</sup>	c. 2583 ft <sup>2</sup>
B001 - A3/A4/B1 Retail/food and drink	250 m <sup>2</sup>	c. 2691 ft <sup>2</sup>
C001 - A1 Retail	223m <sup>2</sup>	c. 2400 ft <sup>2</sup>
C002 - A1 Retail	160m <sup>2</sup>	c. 1722 ft <sup>2</sup>
C003 - A1 Retail	145m <sup>2</sup>	c. 1560 ft <sup>2</sup>
<b>Total</b>	<b>1018 m<sup>2</sup></b>	<b>c. 10956 ft<sup>2</sup></b>
1 <sup>st</sup> Floor Level		
B101 - 2 Bed	67 m <sup>2</sup>	c. 721 ft <sup>2</sup>
B102 - 1 Bed	41 m <sup>2</sup>	c. 441 ft <sup>2</sup>
B106 - 2 Bed	58 m <sup>2</sup>	c. 624 ft <sup>2</sup>
B107 - Studio	23 m <sup>2</sup>	c. 247.5 ft <sup>2</sup>
B110 - Studio	23 m <sup>2</sup>	c. 247.5 ft <sup>2</sup>
C101 - 1 Bed	43 m <sup>2</sup>	c. 463 ft <sup>2</sup>
C102 - 1 Bed	43 m <sup>2</sup>	c. 463 ft <sup>2</sup>
C103 - 1 Bed	43 m <sup>2</sup>	c. 463 ft <sup>2</sup>
C104 - 1 Bed	43 m <sup>2</sup>	c. 463 ft <sup>2</sup>
C105 - 1 Bed	43 m <sup>2</sup>	c. 463 ft <sup>2</sup>
C106 - 1 Bed	43 m <sup>2</sup>	c. 463 ft <sup>2</sup>
C107 - 1 Bed	37 m <sup>2</sup>	c. 398 ft <sup>2</sup>
C108 - 2 Bed	67 m <sup>2</sup>	c. 721 ft <sup>2</sup>
C109 - 2 Bed	59 m <sup>2</sup>	c. 635 ft <sup>2</sup>
<b>Total</b>	<b>633</b>	<b>c. 6813 ft<sup>2</sup></b>
2 <sup>nd</sup> Floor Level		
B201 - 2 Bed	67 m <sup>2</sup>	c. 721 ft <sup>2</sup>
B202 - 1 Bed	41 m <sup>2</sup>	c. 441 ft <sup>2</sup>
B203 - 2 Bed	57 m <sup>2</sup>	c. 614 ft <sup>2</sup>
B206 - 2 Bed	58 m <sup>2</sup>	c. 624 ft <sup>2</sup>
B207 - Studio	23 m <sup>2</sup>	c. 247.5 ft <sup>2</sup>
B210 - Studio	23 m <sup>2</sup>	c. 247.5 ft <sup>2</sup>
C201 - 1 Bed	43 m <sup>2</sup>	c. 463 ft <sup>2</sup>
C202 - 1 Bed	43 m <sup>2</sup>	c. 463 ft <sup>2</sup>
C203 - 1 Bed	43 m <sup>2</sup>	c. 463 ft <sup>2</sup>
C204 - 1 Bed	43 m <sup>2</sup>	c. 463 ft <sup>2</sup>
C205 - 1 Bed	43 m <sup>2</sup>	c. 463 ft <sup>2</sup>
C206 - 1 Bed	43 m <sup>2</sup>	c. 463 ft <sup>2</sup>
C207 - 1 Bed	37 m <sup>2</sup>	c. 398 ft <sup>2</sup>
C208 - 2 Bed	67 m <sup>2</sup>	c. 721 ft <sup>2</sup>
C209 - 2 Bed	59 m <sup>2</sup>	c. 635 ft <sup>2</sup>
<b>Total</b>	<b>690</b>	<b>c. 7427 ft<sup>2</sup></b>
3 <sup>rd</sup> Floor Level		
B301 - 2 Bed	67 m <sup>2</sup>	c. 721 ft <sup>2</sup>
B302 - 1 Bed	41 m <sup>2</sup>	c. 441 ft <sup>2</sup>
B303 - 2 Bed	57 m <sup>2</sup>	c. 614 ft <sup>2</sup>
B304 - 2 Bed	69 m <sup>2</sup>	c. 742.5 ft <sup>2</sup>
B305 - 2 Bed	68.5 m <sup>2</sup>	c. 737 ft <sup>2</sup>
B306 - 2 Bed	58 m <sup>2</sup>	c. 624 ft <sup>2</sup>
B307 - Studio	23 m <sup>2</sup>	c. 247.5 ft <sup>2</sup>
B310 - Studio	23 m <sup>2</sup>	c. 247.5 ft <sup>2</sup>
B308 - Studio	36.5 m <sup>2</sup>	c. 392.5 ft <sup>2</sup>
B309 - Studio	34.5 m <sup>2</sup>	c. 371 ft <sup>2</sup>
C301 - 1 Bed	43 m <sup>2</sup>	c. 463 ft <sup>2</sup>
C302 - 1 Bed	43 m <sup>2</sup>	c. 463 ft <sup>2</sup>
C303 - 1 Bed	43 m <sup>2</sup>	c. 463 ft <sup>2</sup>
C304 - 1 Bed	43 m <sup>2</sup>	c. 463 ft <sup>2</sup>
C305 - 1 Bed	43 m <sup>2</sup>	c. 463 ft <sup>2</sup>
C306 - 1 Bed	43 m <sup>2</sup>	c. 463 ft <sup>2</sup>
C307 - 1 Bed	37 m <sup>2</sup>	c. 398 ft <sup>2</sup>
C308 - 2 Bed	67 m <sup>2</sup>	c. 721 ft <sup>2</sup>
C309 - 2 Bed	59 m <sup>2</sup>	c. 635 ft <sup>2</sup>
<b>Total</b>	<b>898.5</b>	<b>c. 9669 ft<sup>2</sup></b>

4 <sup>th</sup> Floor Level		
B401 - 2 Bed	67 m <sup>2</sup>	c. 721 ft <sup>2</sup>
B402 - 1 Bed	41 m <sup>2</sup>	c. 441 ft <sup>2</sup>
B403 - 2 Bed	57 m <sup>2</sup>	c. 614 ft <sup>2</sup>
B404 - 2 Bed	69 m <sup>2</sup>	c. 742.5 ft <sup>2</sup>
B405 - 2 Bed	68.5 m <sup>2</sup>	c. 737 ft <sup>2</sup>
B406 - 2Bed	58 m <sup>2</sup>	c. 624 ft <sup>2</sup>
B407 - Studio	23 m <sup>2</sup>	c. 247.5 ft <sup>2</sup>
B410 - Studio	23 m <sup>2</sup>	c. 247.5 ft <sup>2</sup>
B408 - Studio	36.5 m <sup>2</sup>	c. 392.5 ft <sup>2</sup>
B409 - Studio	34.5 m <sup>2</sup>	c. 371 ft <sup>2</sup>
C401 - 1 Bed	43 m <sup>2</sup>	c. 463 ft <sup>2</sup>
C402 - 1 Bed	43 m <sup>2</sup>	c. 463 ft <sup>2</sup>
C403 - 1 Bed	43 m <sup>2</sup>	c. 463 ft <sup>2</sup>
C404 - 1 Bed	43 m <sup>2</sup>	c. 463 ft <sup>2</sup>
C405 - 1 Bed	43 m <sup>2</sup>	c. 463 ft <sup>2</sup>
C406 - 1 Bed	43 m <sup>2</sup>	c. 463 ft <sup>2</sup>
C407 - 1 Bed	37 m <sup>2</sup>	c. 398 ft <sup>2</sup>
C408 - 2 Bed	67 m <sup>2</sup>	c. 721 ft <sup>2</sup>
C409 - 2 Bed	59 m <sup>2</sup>	c. 635 ft <sup>2</sup>
<b>Total</b>	<b>898.5</b>	<b>c. 9669 ft<sup>2</sup></b>
5 <sup>th</sup> Floor Level		
B501 - 2 Bed	78 m <sup>2</sup>	c. 840 ft <sup>2</sup>
B503 - 2 Bed	57 m <sup>2</sup>	c. 614 ft <sup>2</sup>
B504 - 2 Bed	69 m <sup>2</sup>	c. 742.5 ft <sup>2</sup>
B505 - 2 Bed	68.5 m <sup>2</sup>	c. 737 ft <sup>2</sup>
B506 - 2 Bed	58 m <sup>2</sup>	c. 624 ft <sup>2</sup>
B507 - 1 Bed	44 m <sup>2</sup>	c. 474 ft <sup>2</sup>
B508 - Studio	36.5 m <sup>2</sup>	c. 392.5 ft <sup>2</sup>
B509 - Studio	34.5 m <sup>2</sup>	c. 371 ft <sup>2</sup>
C501 - 1 Bed	40 m <sup>2</sup>	c. 430.5 ft <sup>2</sup>
C502 - 1 Bed	40 m <sup>2</sup>	c. 430.5 ft <sup>2</sup>
C503 - 1 Bed	40 m <sup>2</sup>	c. 430.5 ft <sup>2</sup>
C504 - 1 Bed	40m <sup>2</sup>	c. 430.5 ft <sup>2</sup>
C505 - 1 Bed	40 m <sup>2</sup>	c. 430.5 ft <sup>2</sup>
C506 - 1 Bed	40 m <sup>2</sup>	c. 430.5 ft <sup>2</sup>
C507 - 1 Bed	32 m <sup>2</sup>	c. 344 ft <sup>2</sup>
C508 - 2 Bed	63 m <sup>2</sup>	c. 678 ft <sup>2</sup>
<b>Total</b>	<b>780.5</b>	<b>c. 8400 ft<sup>2</sup></b>
6 <sup>th</sup> Floor Level		
B603- 2 Bed	57 m <sup>2</sup>	c. 614 ft <sup>2</sup>
B604- 2 Bed	69 m <sup>2</sup>	c. 742.5 ft <sup>2</sup>
B605- 2 Bed	68.5 m <sup>2</sup>	c. 737 ft <sup>2</sup>
B606- 2 Bed	58 m <sup>2</sup>	c. 624 ft <sup>2</sup>
<b>Total</b>	<b>252.5 m<sup>2</sup></b>	<b>c. 2717.5 ft<sup>2</sup></b>
7 <sup>th</sup> Floor Level		
B703- 2 Bed	57 m <sup>2</sup>	c. 614 ft <sup>2</sup>
B704- 2 Bed	69 m <sup>2</sup>	c. 742.5 ft <sup>2</sup>
B705- 2 Bed	68.5 m <sup>2</sup>	c. 737 ft <sup>2</sup>
B706- 2 Bed	58 m <sup>2</sup>	c. 624 ft <sup>2</sup>
<b>Total</b>	<b>252.5 m<sup>2</sup></b>	<b>c. 2717.5 ft<sup>2</sup></b>
8 <sup>th</sup> Floor Level		
B803- 2 Bed	57 m <sup>2</sup>	c. 614 ft <sup>2</sup>
B804- 2 Bed	69 m <sup>2</sup>	c. 742.5 ft <sup>2</sup>
B805- 2 Bed	68.5 m <sup>2</sup>	c. 737 ft <sup>2</sup>
B806- 2 Bed	58 m <sup>2</sup>	c. 624 ft <sup>2</sup>
<b>Total</b>	<b>252.5 m<sup>2</sup></b>	<b>c. 2717.5 ft<sup>2</sup></b>
9 <sup>th</sup> Floor Level		
B903- 2 Bed	57 m <sup>2</sup>	c. 614 ft <sup>2</sup>
B904- 2 Bed	69 m <sup>2</sup>	c. 742.5 ft <sup>2</sup>
B905- 2 Bed	68.5 m <sup>2</sup>	c. 737 ft <sup>2</sup>
B906- 2 Bed	58 m <sup>2</sup>	c. 624 ft <sup>2</sup>
<b>Total</b>	<b>252.5 m<sup>2</sup></b>	<b>c. 2717.5 ft<sup>2</sup></b>

10 <sup>th</sup> Floor Level		
B1003- 2 Bed	57 m <sup>2</sup>	c. 614 ft <sup>2</sup>
B1004- 2 Bed	69 m <sup>2</sup>	c. 742.5 ft <sup>2</sup>
B1005- 2 Bed	68.5 m <sup>2</sup>	c. 737 ft <sup>2</sup>
B1006- 2 Bed	58 m <sup>2</sup>	c. 624 ft <sup>2</sup>
<b>Total</b>	<b>252.5 m<sup>2</sup></b>	<b>c. 2717.5 ft<sup>2</sup></b>
11 <sup>th</sup> Floor Level		
B1103- 2 Bed	57 m <sup>2</sup>	c. 614 ft <sup>2</sup>
B1104- 2 Bed	69 m <sup>2</sup>	c. 742.5 ft <sup>2</sup>
B1105- 2 Bed	68.5 m <sup>2</sup>	c. 737 ft <sup>2</sup>
B1006- 2 Bed	58 m <sup>2</sup>	c. 624 ft <sup>2</sup>
<b>Total</b>	<b>252.5 m<sup>2</sup></b>	<b>c. 2717.5 ft<sup>2</sup></b>
12 <sup>th</sup> Floor Level		
B1203- 2 Bed	57 m <sup>2</sup>	c. 614 ft <sup>2</sup>
B1204- 2 Bed	69 m <sup>2</sup>	c. 742.5 ft <sup>2</sup>
B1205- 2 Bed	68.5 m <sup>2</sup>	c. 737 ft <sup>2</sup>
B1206- 2 Bed	58 m <sup>2</sup>	c. 624 ft <sup>2</sup>
<b>Total</b>	<b>252.5 m<sup>2</sup></b>	<b>c. 2717.5 ft<sup>2</sup></b>
13 <sup>th</sup> Floor Level		
B1303- 2 Bed	57 m <sup>2</sup>	c. 614 ft <sup>2</sup>
B1304- 2 Bed	69 m <sup>2</sup>	c. 742.5 ft <sup>2</sup>
B1305- 2 Bed	68.5 m <sup>2</sup>	c. 737 ft <sup>2</sup>
B1306- 2 Bed	58 m <sup>2</sup>	c. 624 ft <sup>2</sup>
<b>Total</b>	<b>252.5 m<sup>2</sup></b>	<b>c. 2717.5 ft<sup>2</sup></b>
14 <sup>th</sup> Floor Level		
B1403- 2 Bed	57 m <sup>2</sup>	c. 614 ft <sup>2</sup>
B1404- 2 Bed	69 m <sup>2</sup>	c. 742.5 ft <sup>2</sup>
B1405- 2 Bed	68.5 m <sup>2</sup>	c. 737 ft <sup>2</sup>
B1406- 2 Bed	58 m <sup>2</sup>	c. 624 ft <sup>2</sup>
<b>Total</b>	<b>252.5 m<sup>2</sup></b>	<b>c. 2717.5 ft<sup>2</sup></b>
15 <sup>th</sup> Floor Level		
B1503- 2 Bed	57 m <sup>2</sup>	c. 614 ft <sup>2</sup>
B1504- 2 Bed	69 m <sup>2</sup>	c. 742.5 ft <sup>2</sup>
B1505- 3 Bed	68.5 m <sup>2</sup>	c. 737 ft <sup>2</sup>
B1506- 2 Bed	58 m <sup>2</sup>	c. 624 ft <sup>2</sup>
<b>Total</b>	<b>252.5 m<sup>2</sup></b>	<b>c. 2717.5 ft<sup>2</sup></b>
Grand Total (all types)		
	<b>6425.5 m<sup>2</sup></b>	<b>c. 69155 ft<sup>2</sup></b>
<b>A002 - 4 Bed Townhouse</b>	<b>96 m<sup>2</sup></b>	<b>c. 1030 ft<sup>2</sup></b>
A101 to A102- Office Space	271 m <sup>2</sup>	c. 2915 ft <sup>2</sup>
A201 to A202 - Office space	271 m <sup>2</sup>	c. 2915 ft <sup>2</sup>
A301 to A302 - Office space	242 m <sup>2</sup>	c. 2600 ft <sup>2</sup>
<b>Total</b>	<b>784 m<sup>2</sup></b>	<b>c. 8437 ft<sup>2</sup></b>
<b>Grand Total</b>	<b>8334 m<sup>2</sup></b>	<b>c. 89688 ft<sup>2</sup></b>

Total Number of Residential		
Studio	14	
1 Bed Apartments	39	
2 Bed Apartments	69	
4 Bed Townhouse	1	
<b>Grand Total</b>	<b>123</b>	



1st Floor C109  
2nd Floor C209  
3rd Floor C309  
4th Floor C409

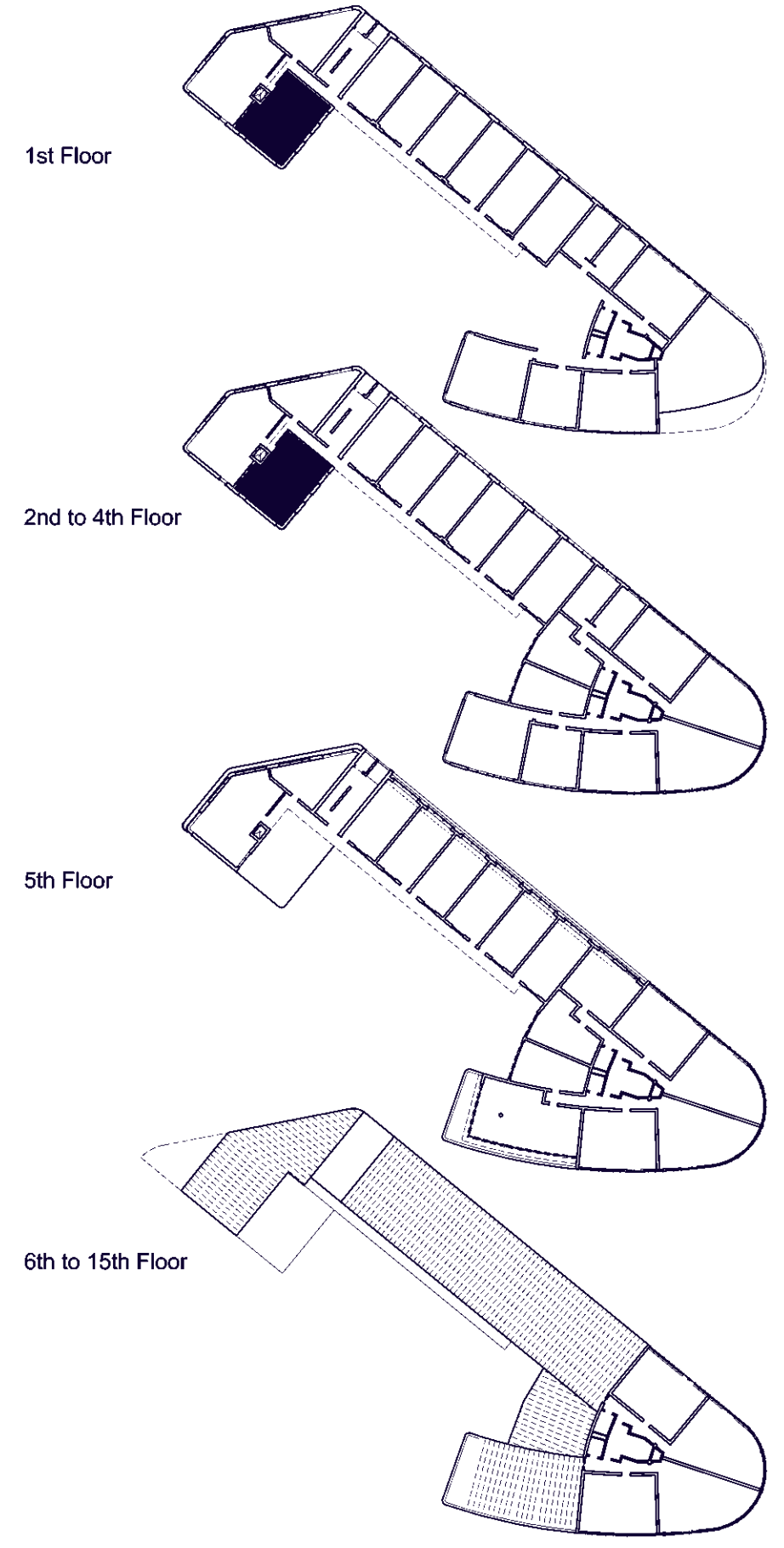
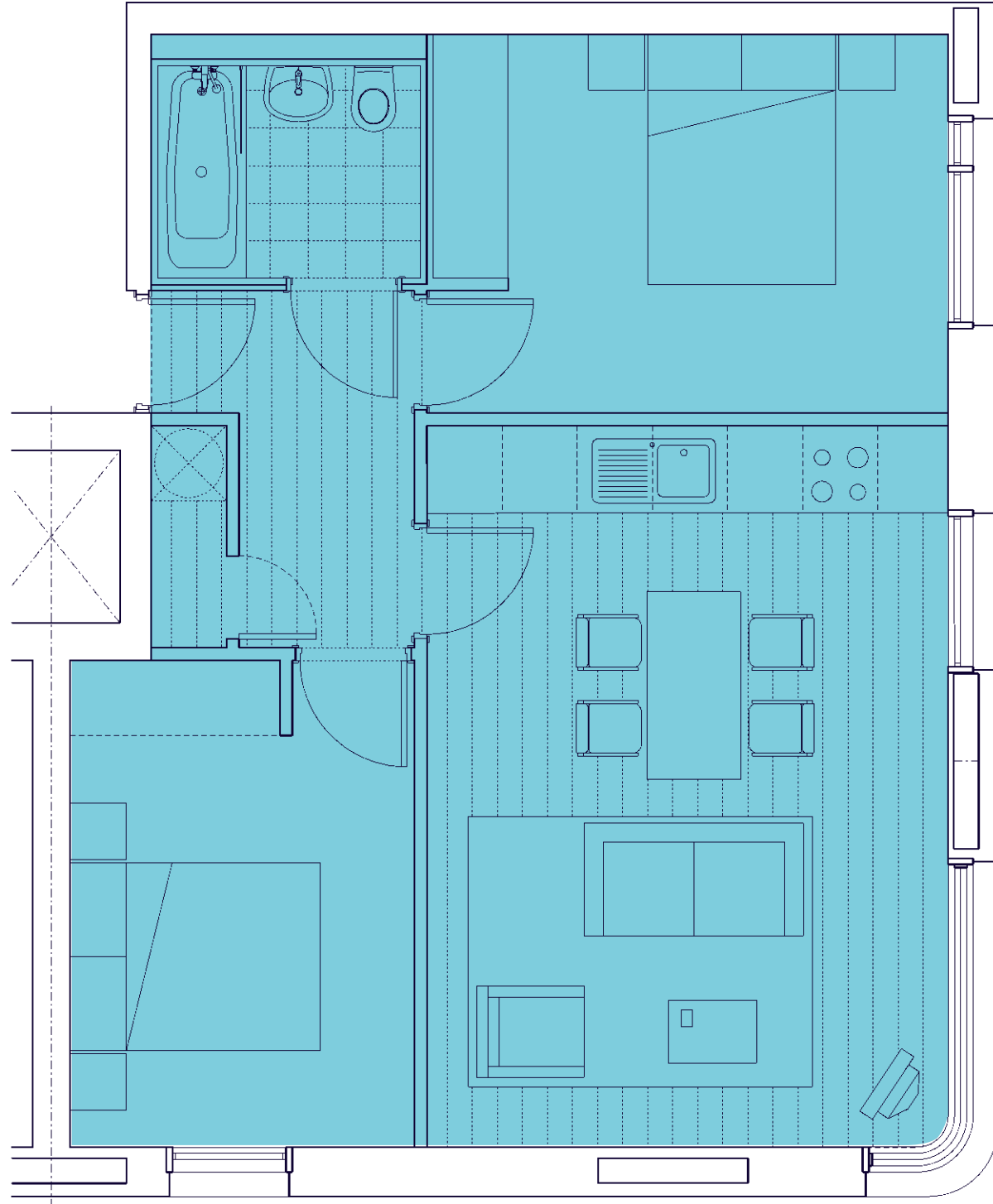

01

2 BF Bedroom, Type A  
Total = 4

59 m<sup>2</sup>  
1:50





1st Floor C108  
2nd Floor C208  
3rd Floor C308  
4th Floor C408

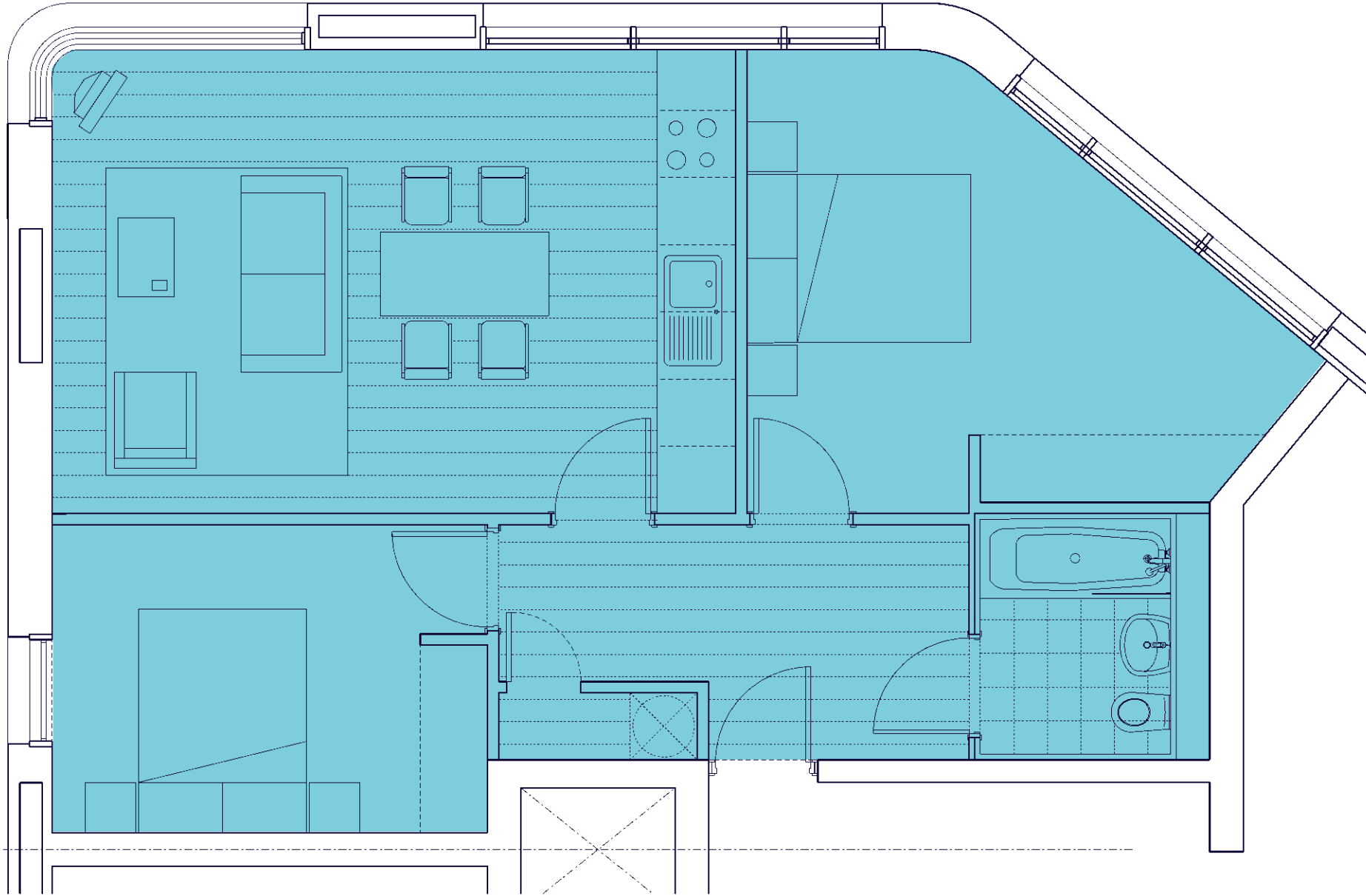

1st Floor

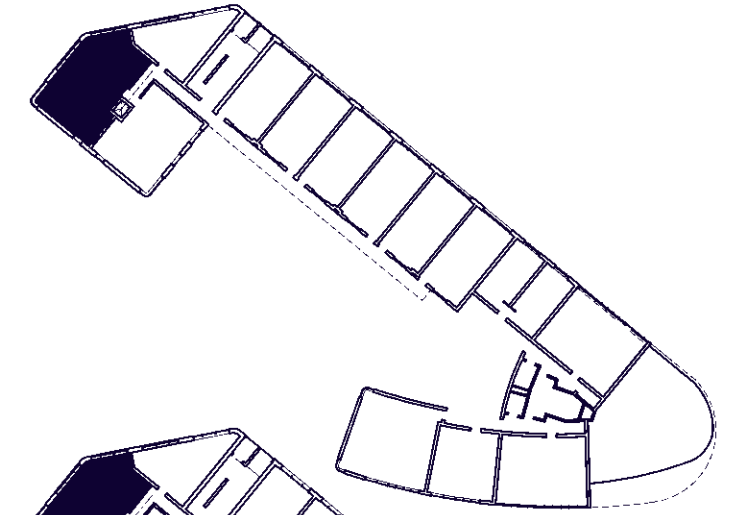

2nd to 4th Floor

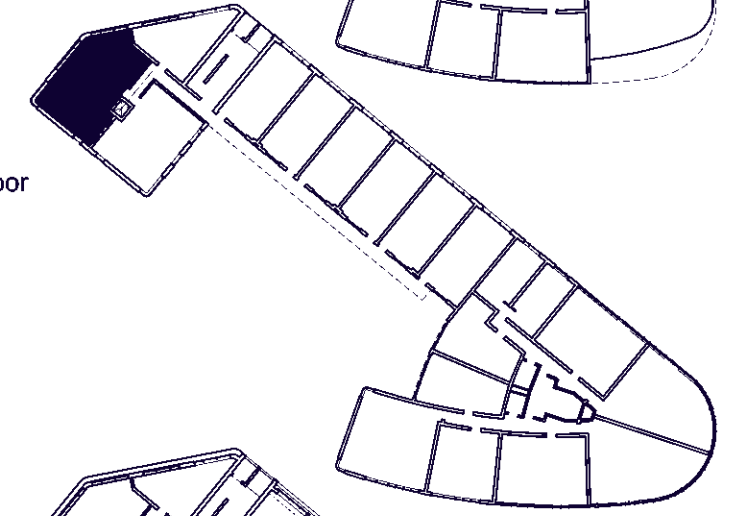

5th Floor

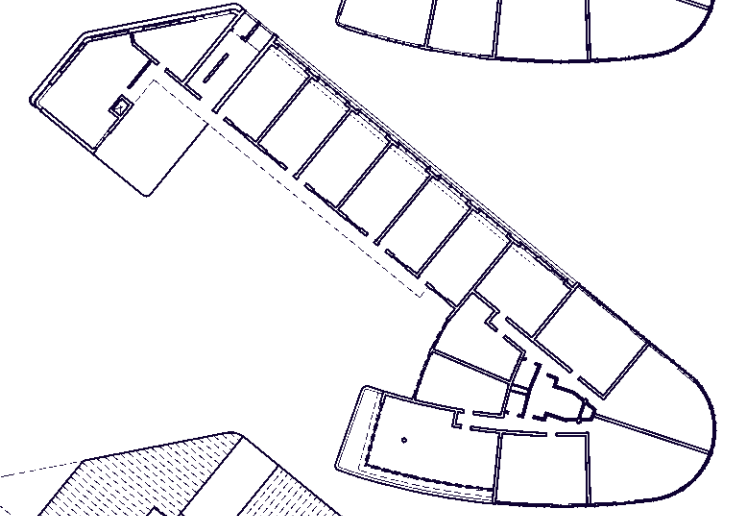

6th to 15th Floor

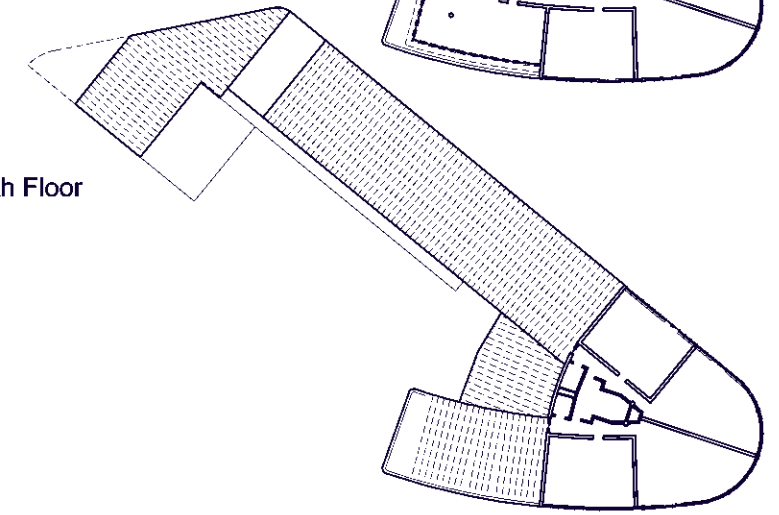

01

2 BF Bedroom, Type B  
Total =4

67 m<sup>2</sup>  
1:50



1st Floor B106 9th Floor B906  
2nd Floor B206 10th Floor B1006  
3rd Floor B306 11th Floor B1106  
4th Floor B406 12th Floor B1206  
5th Floor B506 13th Floor B1306  
6th Floor B606 14th Floor B1406  
7th Floor B706 15th Floor B1506  
8th Floor B806

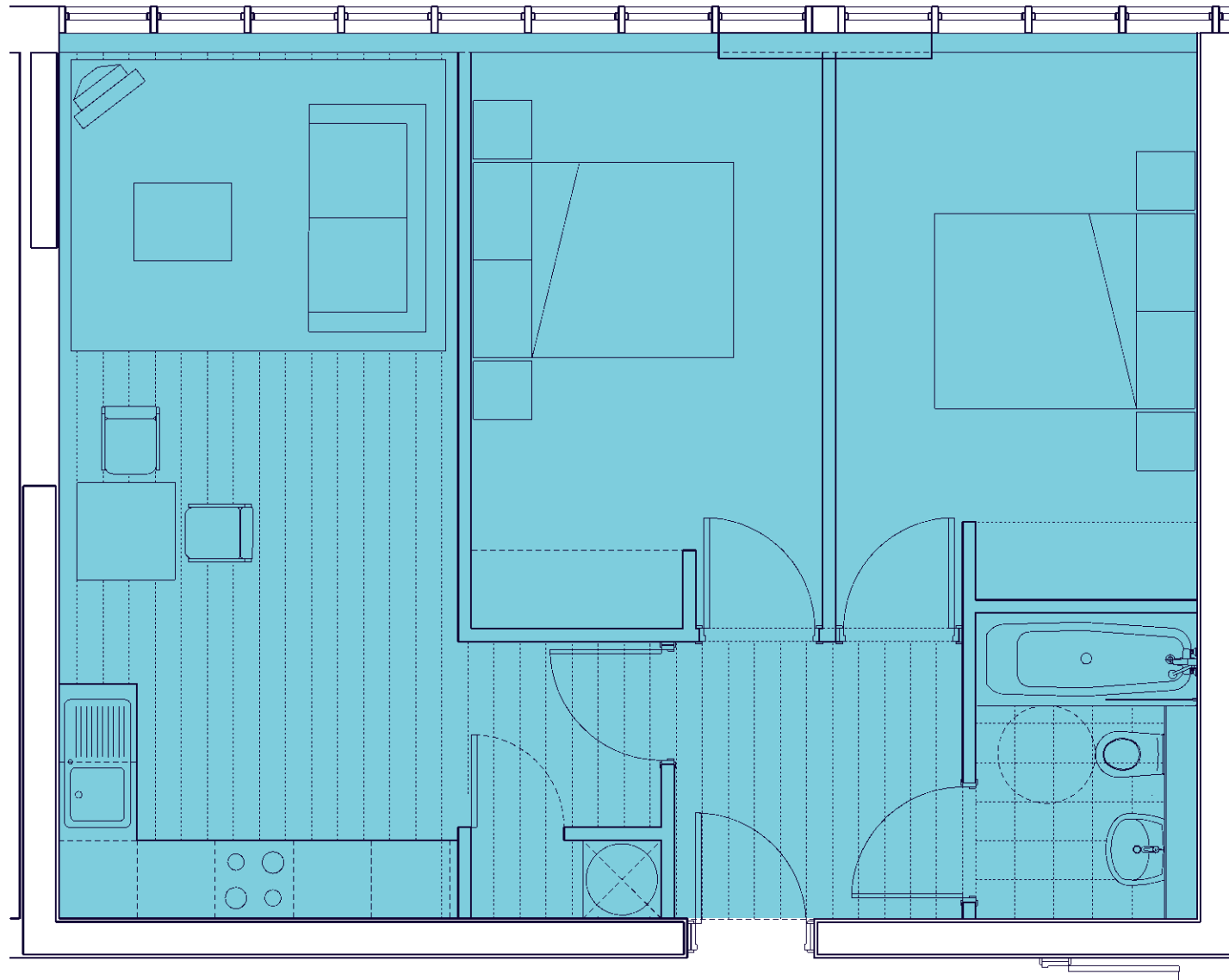

01

2 BF Bedroom, Type F  
Total = 15

58 m2  
1:50

1st Floor

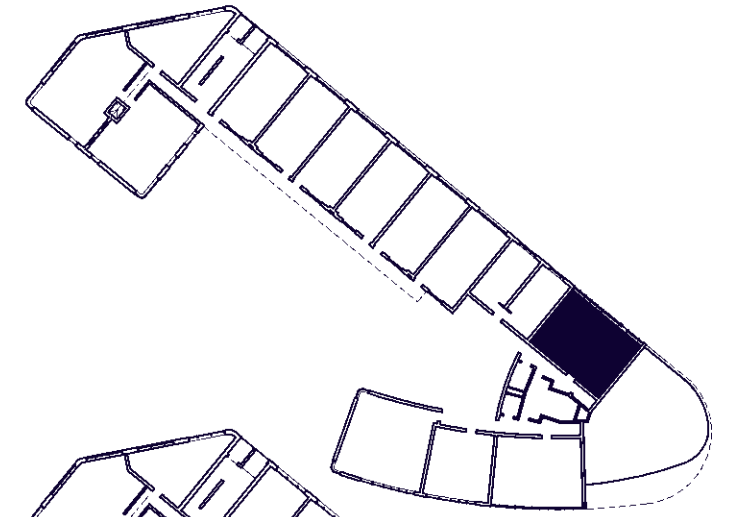

2nd to 4th Floor

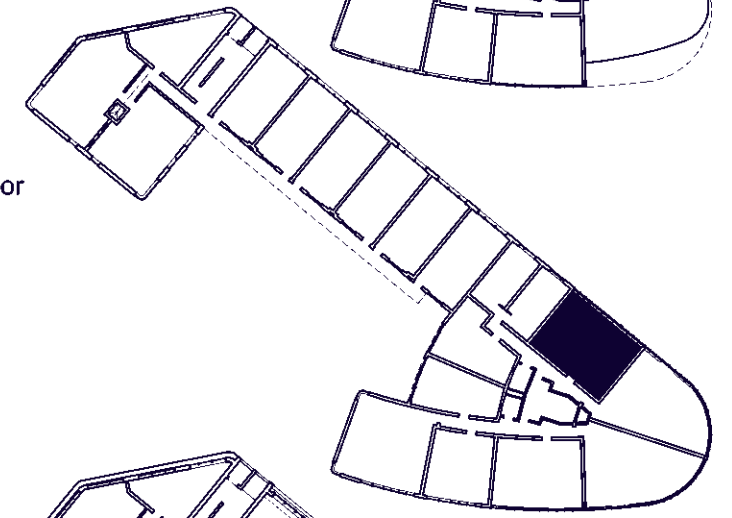

5th Floor

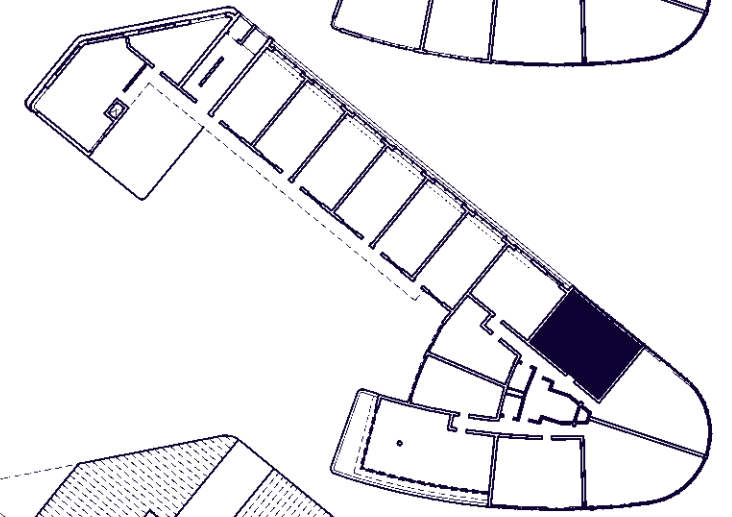

6th to 15th Floor

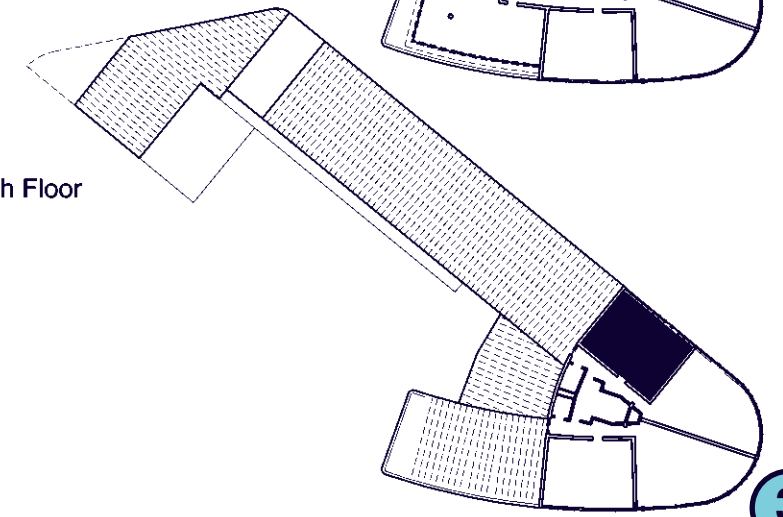



1st Floor C107  
2nd Floor C207  
3rd Floor C307  
4th Floor C407

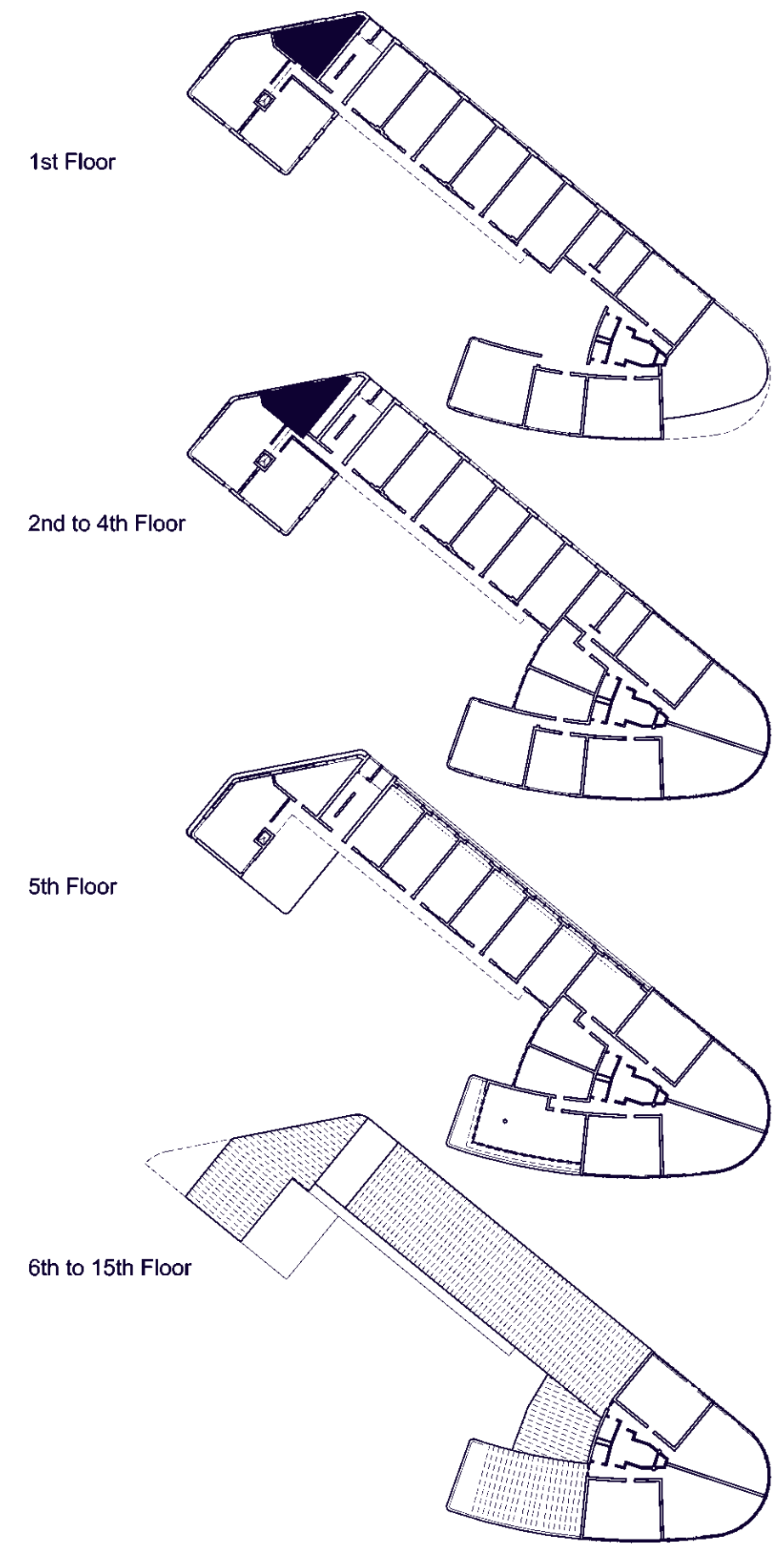
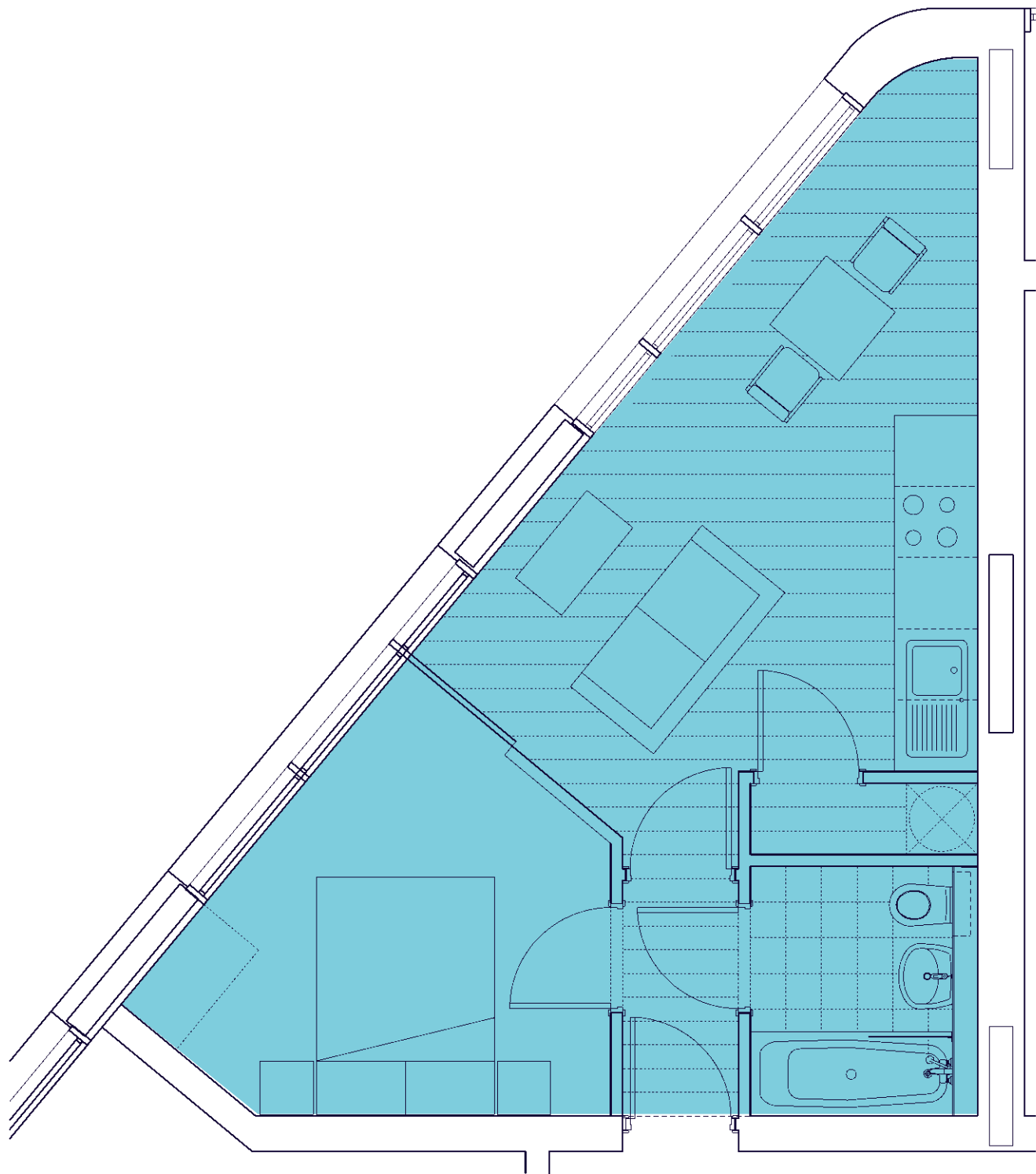

01 1 BF Bedroom, Type C  
Total =4

37 m<sup>2</sup>  
1:50



- 1st Floor B107
- 1st Floor B110
- 2nd Floor B207
- 2nd Floor B210
- 3rd Floor B307
- 3rd Floor B310
- 4th Floor B407
- 4th Floor B407

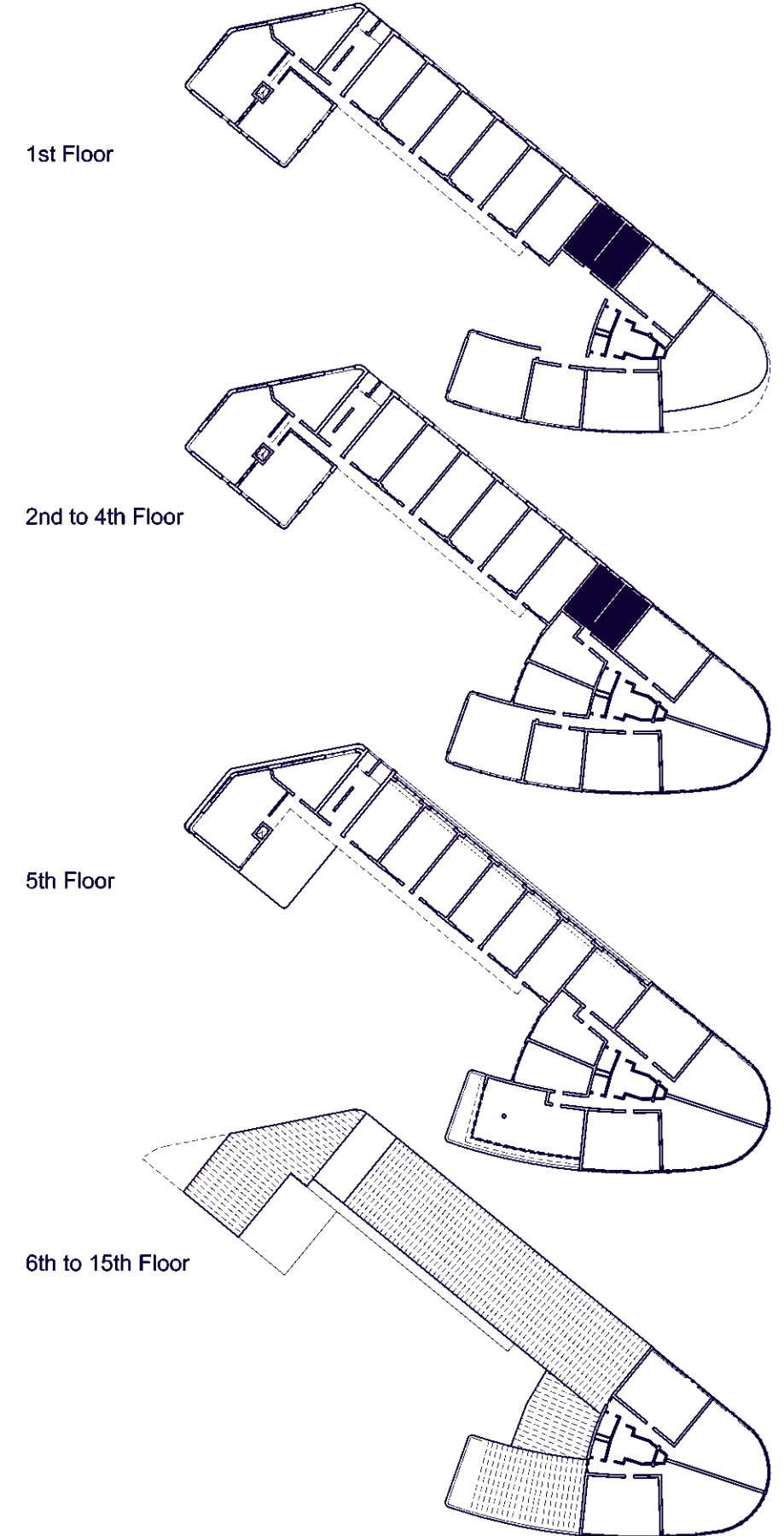
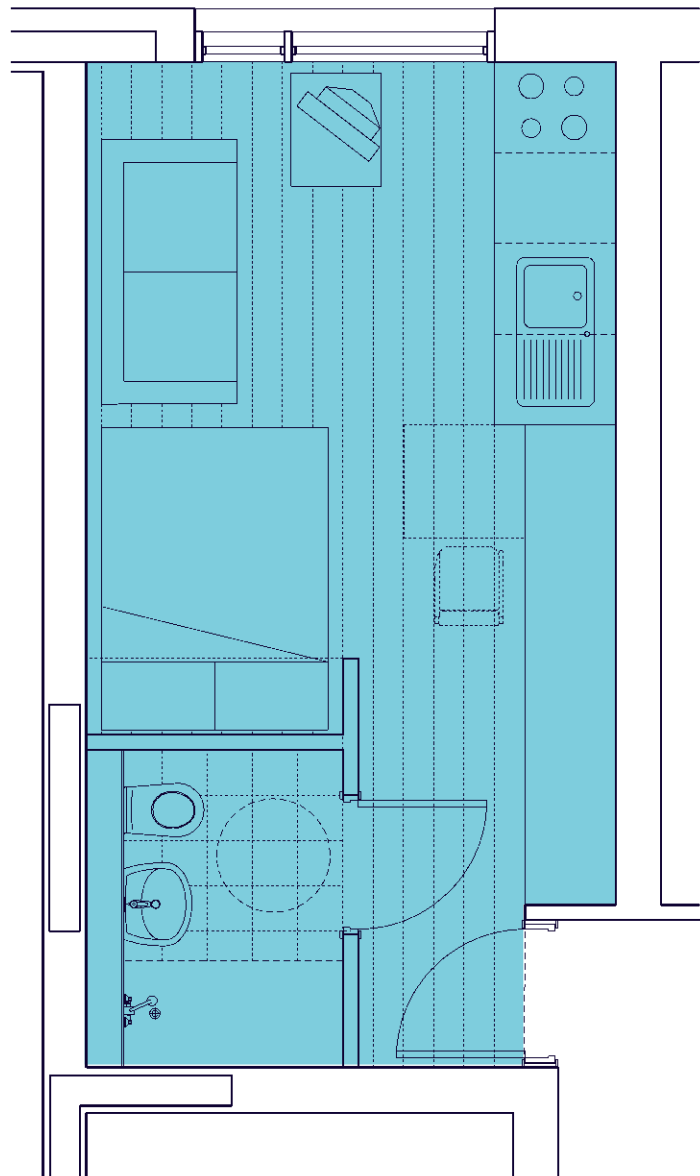

01

1 SF Bedroom, Type E  
Total =8

23 m<sup>2</sup>  
1:50





5th Floor B501

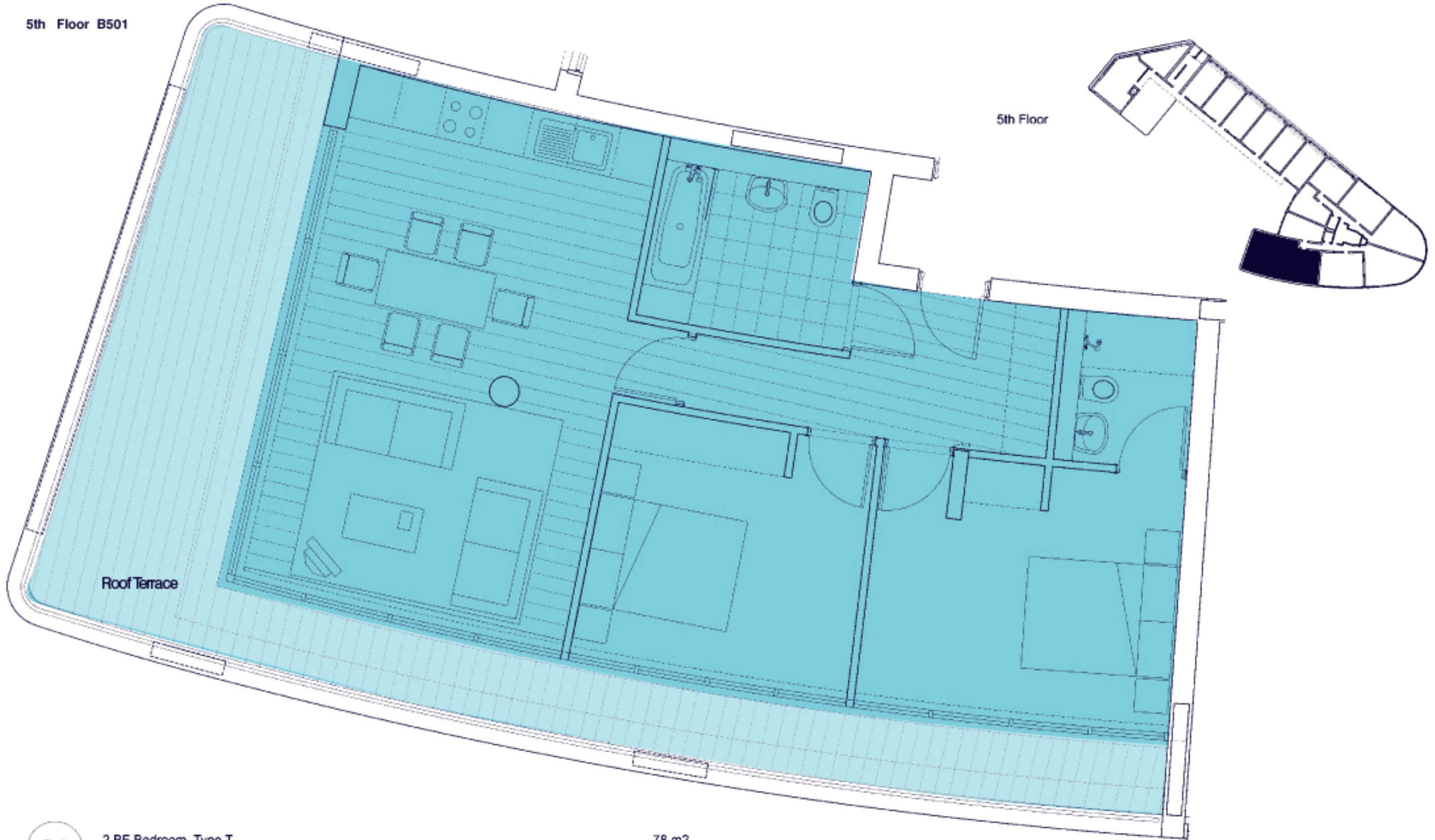

01 2 BF Bedroom, Type T  
Total = 1

78 m2  
1:50



5th Floor B507

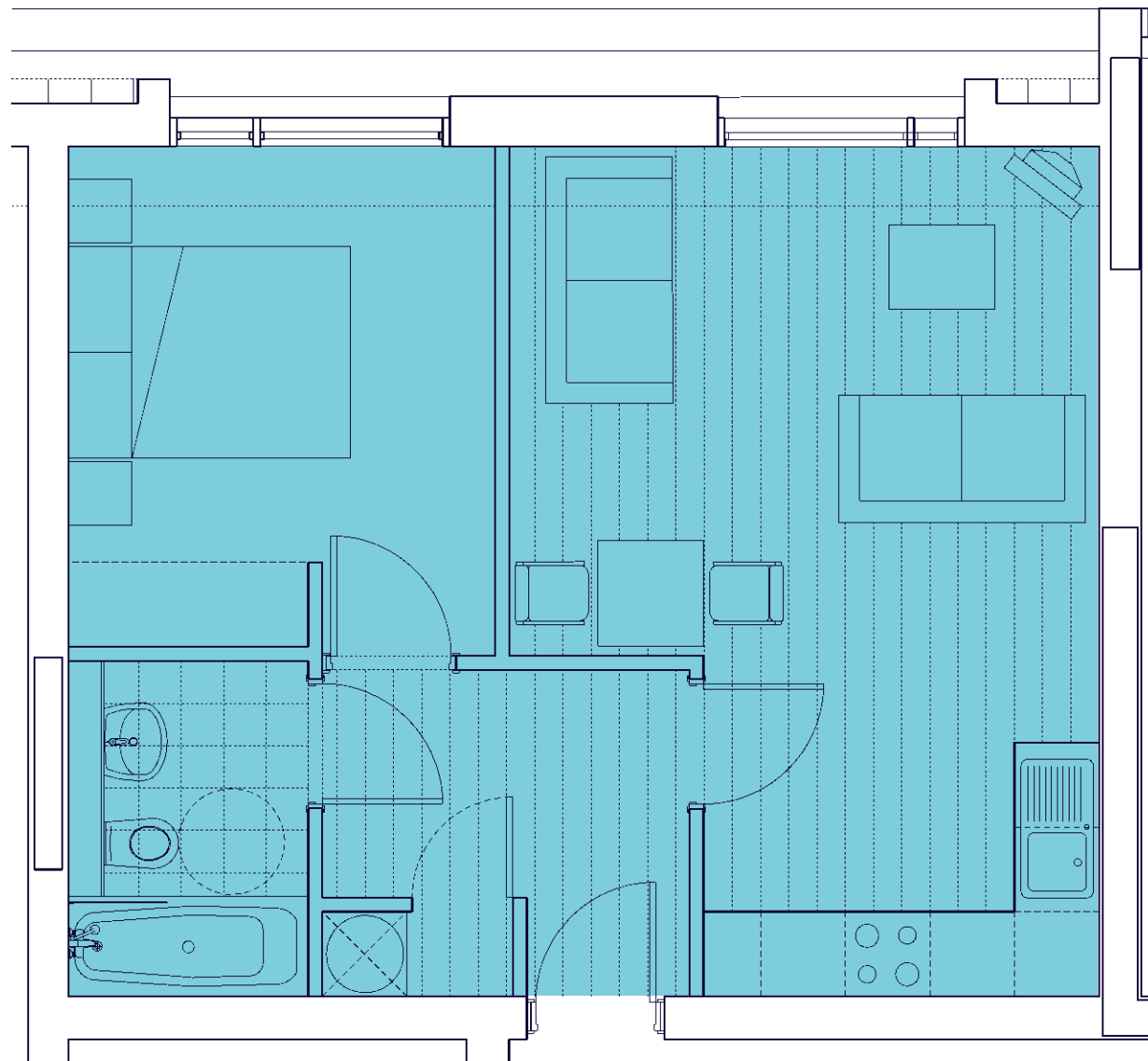

01 2 BF Bedroom, Type S  
Total = 1

44 m<sup>2</sup>  
1:50

1st Floor

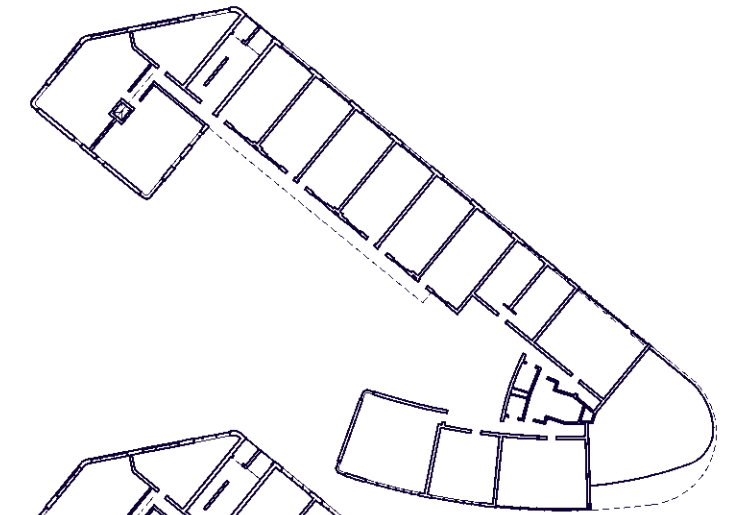

2nd to 4th Floor

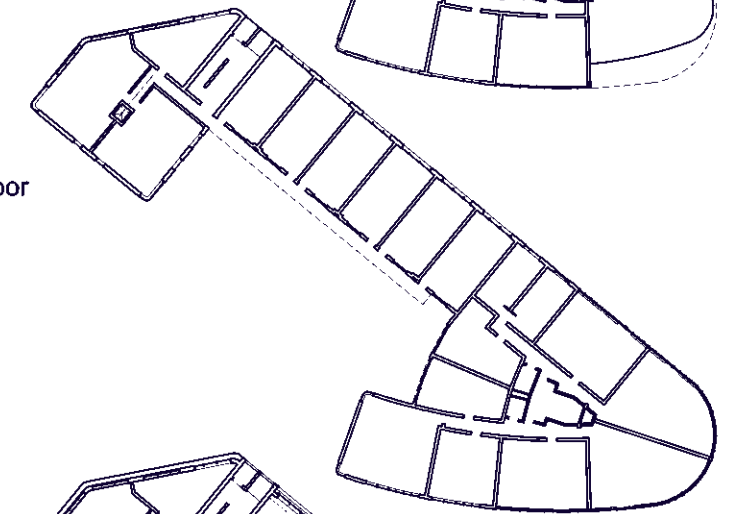

5th Floor

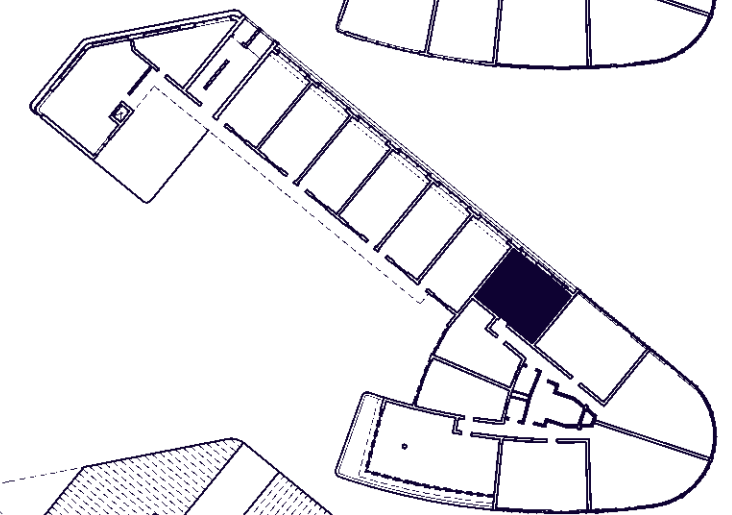

6th to 15th Floor

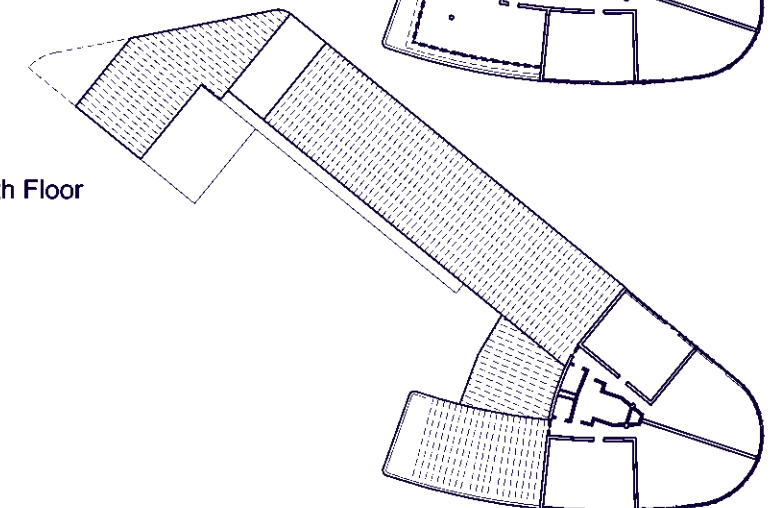



5th Floor C501  
5th Floor C502  
5th Floor C503  
5th Floor C504  
5th Floor C505  
5th Floor C506

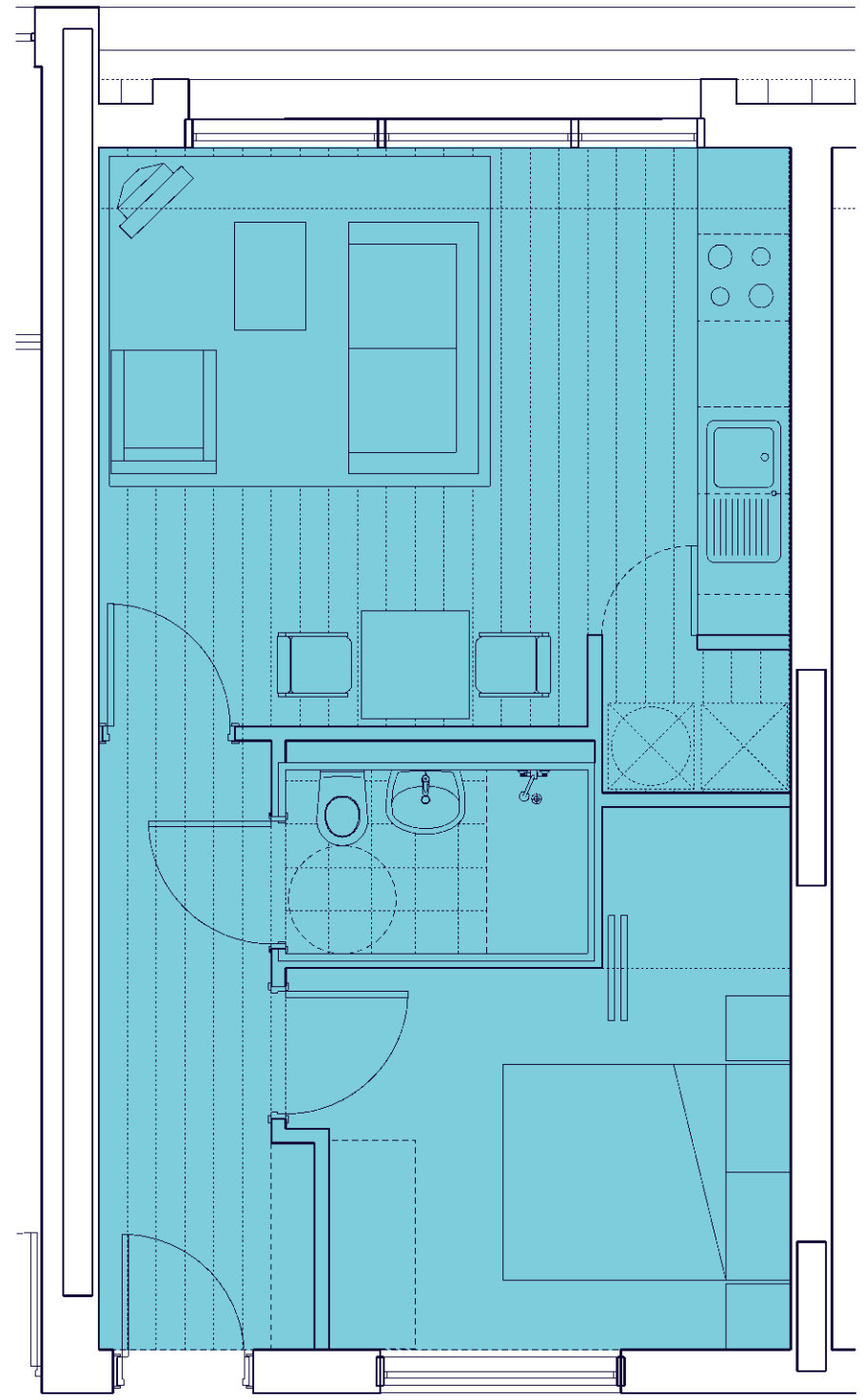

1st Floor

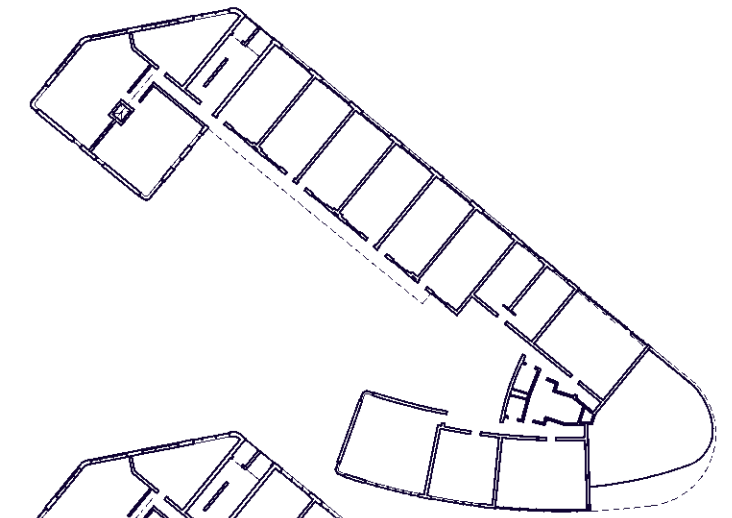

2nd to 4th Floor

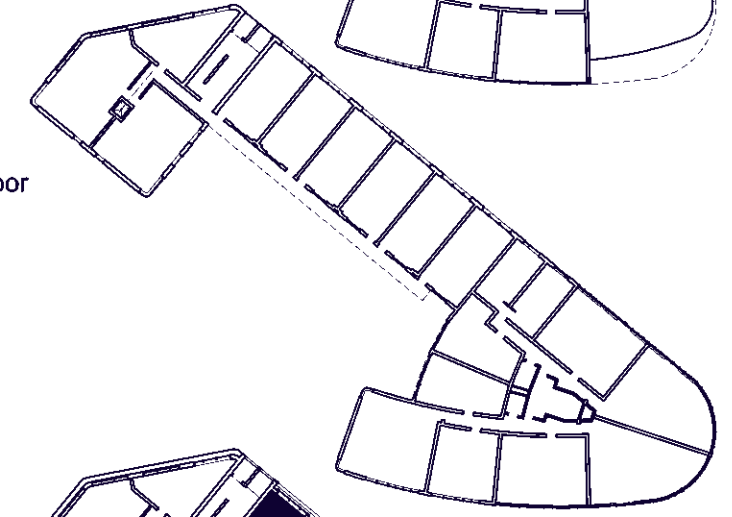

5th Floor

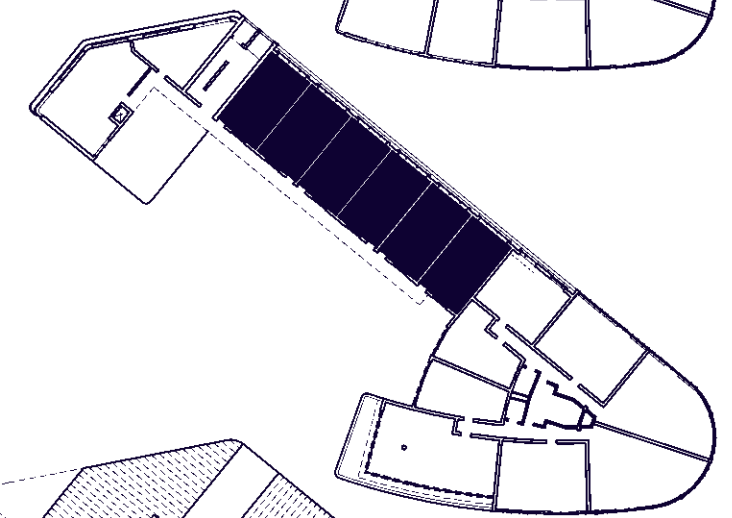

6th to 15th Floor

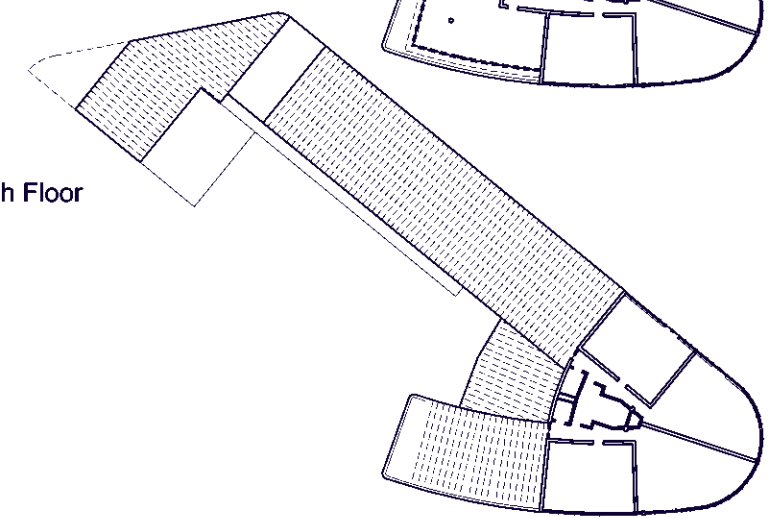

01

1 BF Bedroom, Type R  
Total =6

40 m2  
1:50





5th Floor C507



01

1 BF Bedroom, Type M  
Total =1

32 m2  
1:50

1st Floor

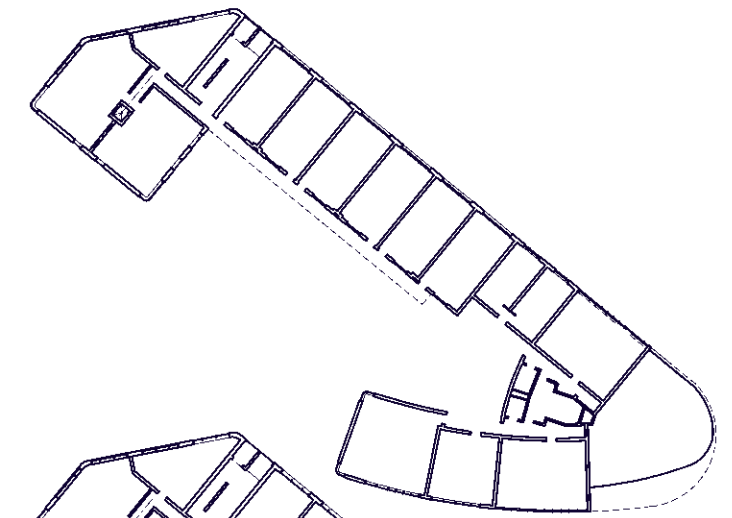

2nd to 4th Floor

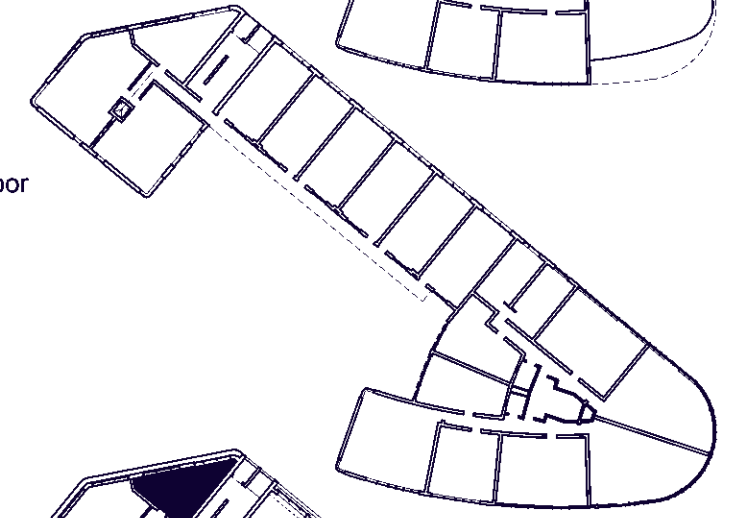

5th Floor

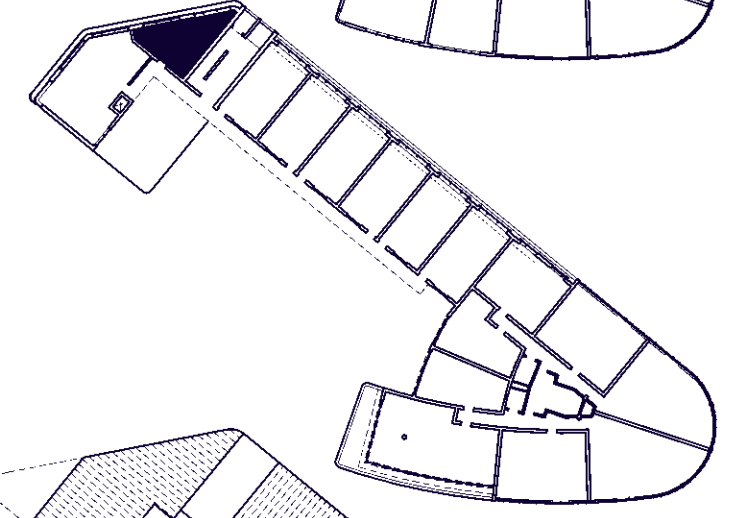

6th to 15th Floor

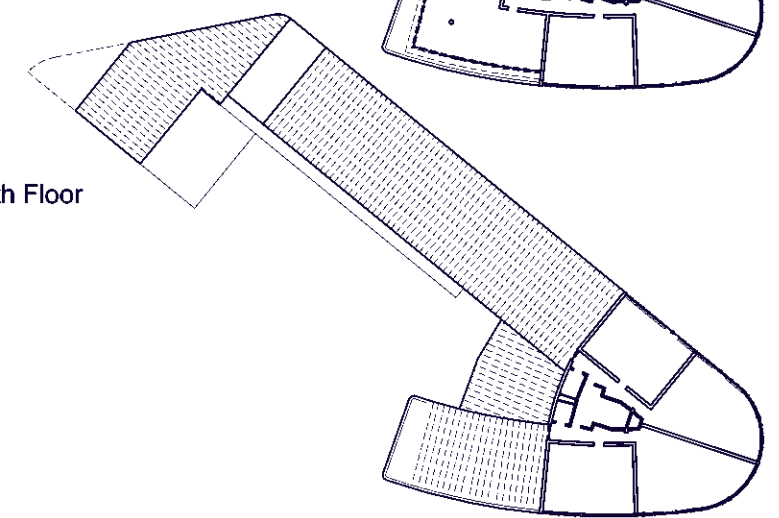





5th Floor C508

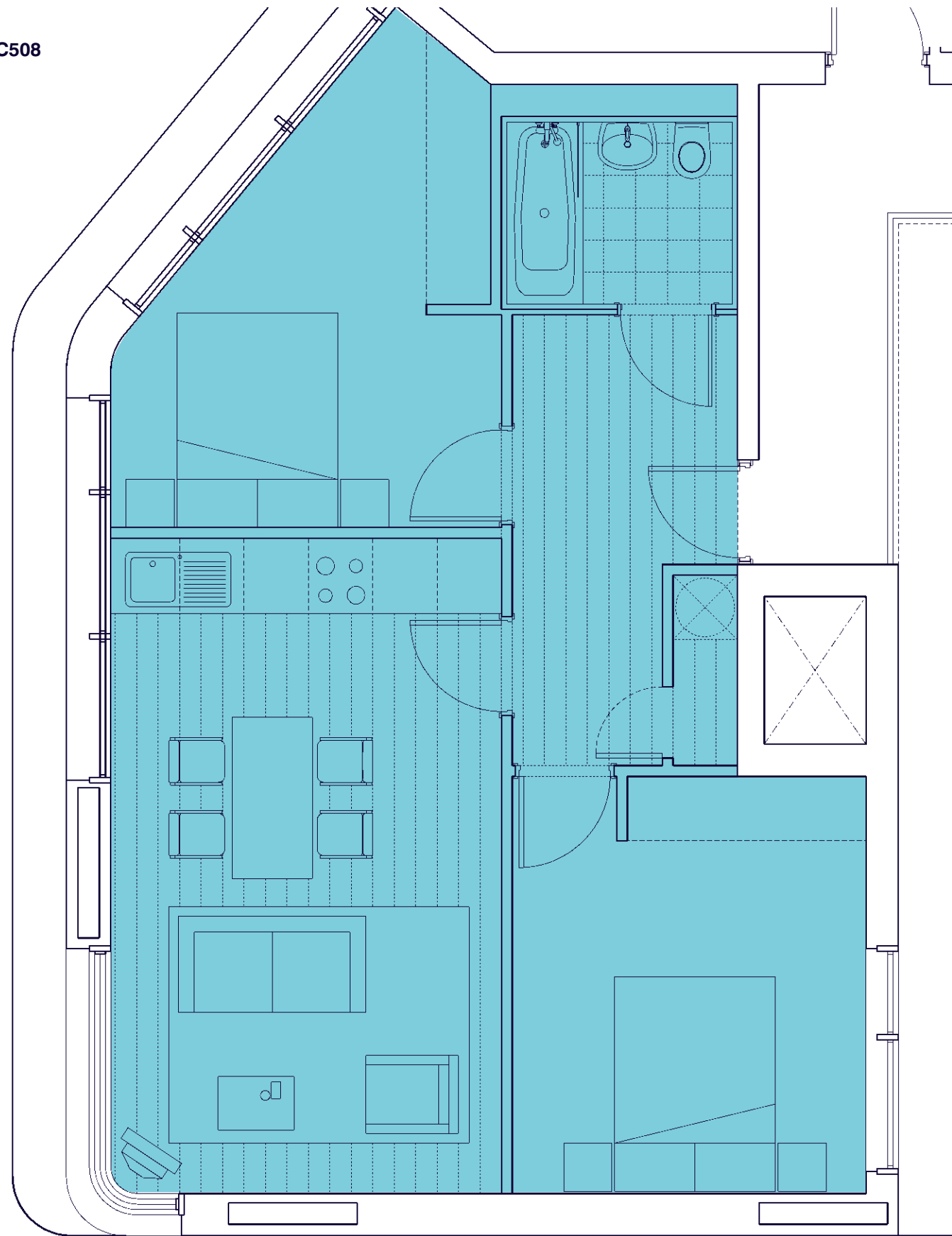

01

2 BF Bedroom, Type P  
Total = 1

63 m<sup>2</sup>  
1:50

1st Floor

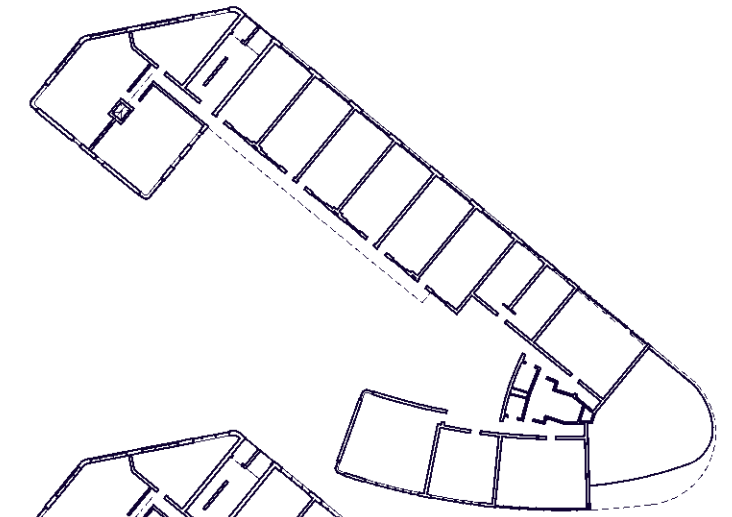

2nd to 4th Floor

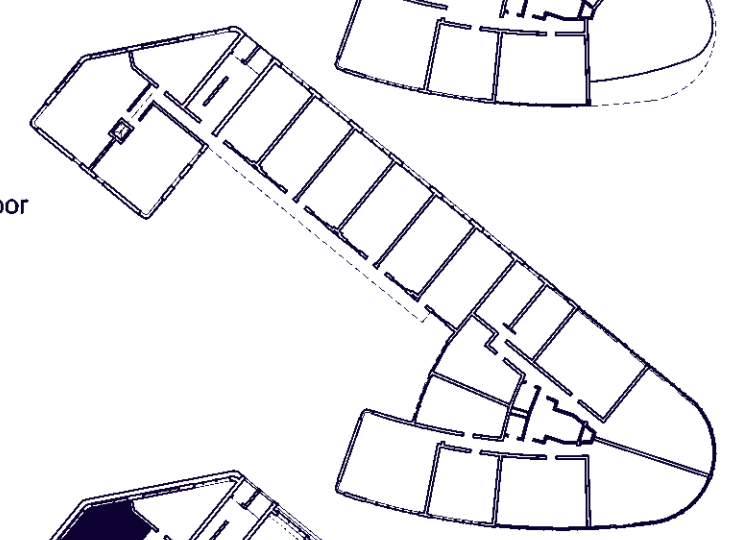

5th Floor

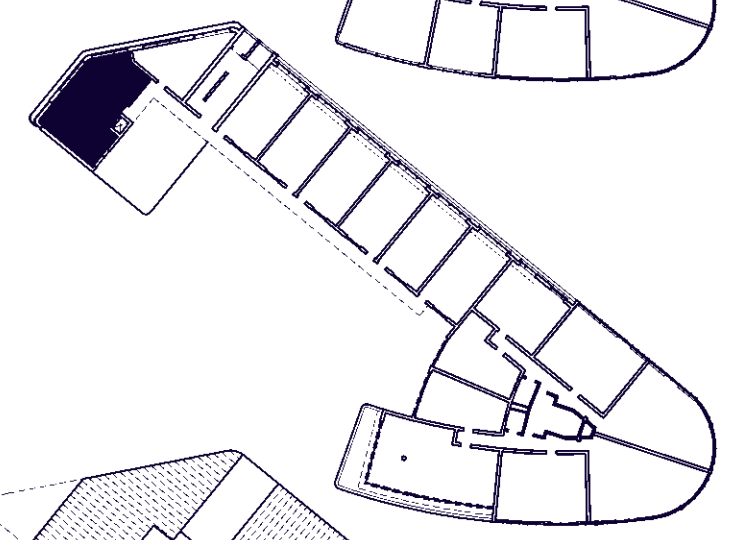

6th to 15th Floor

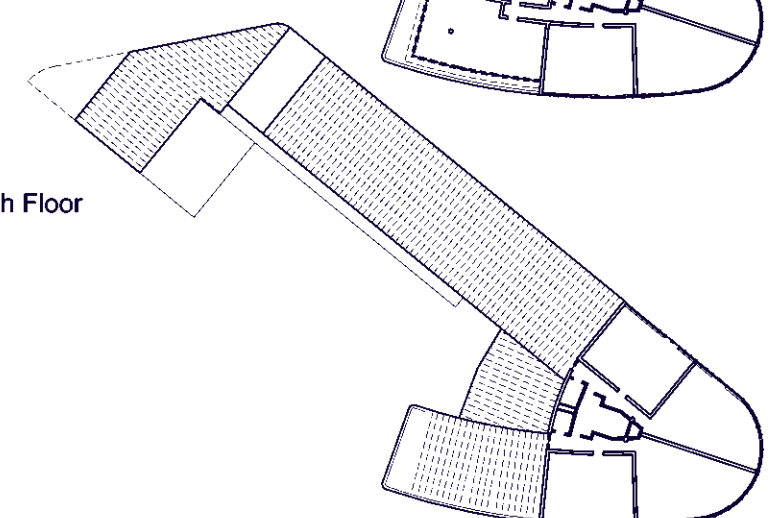



3rd Floor B308  
4th Floor B408  
5th Floor B508

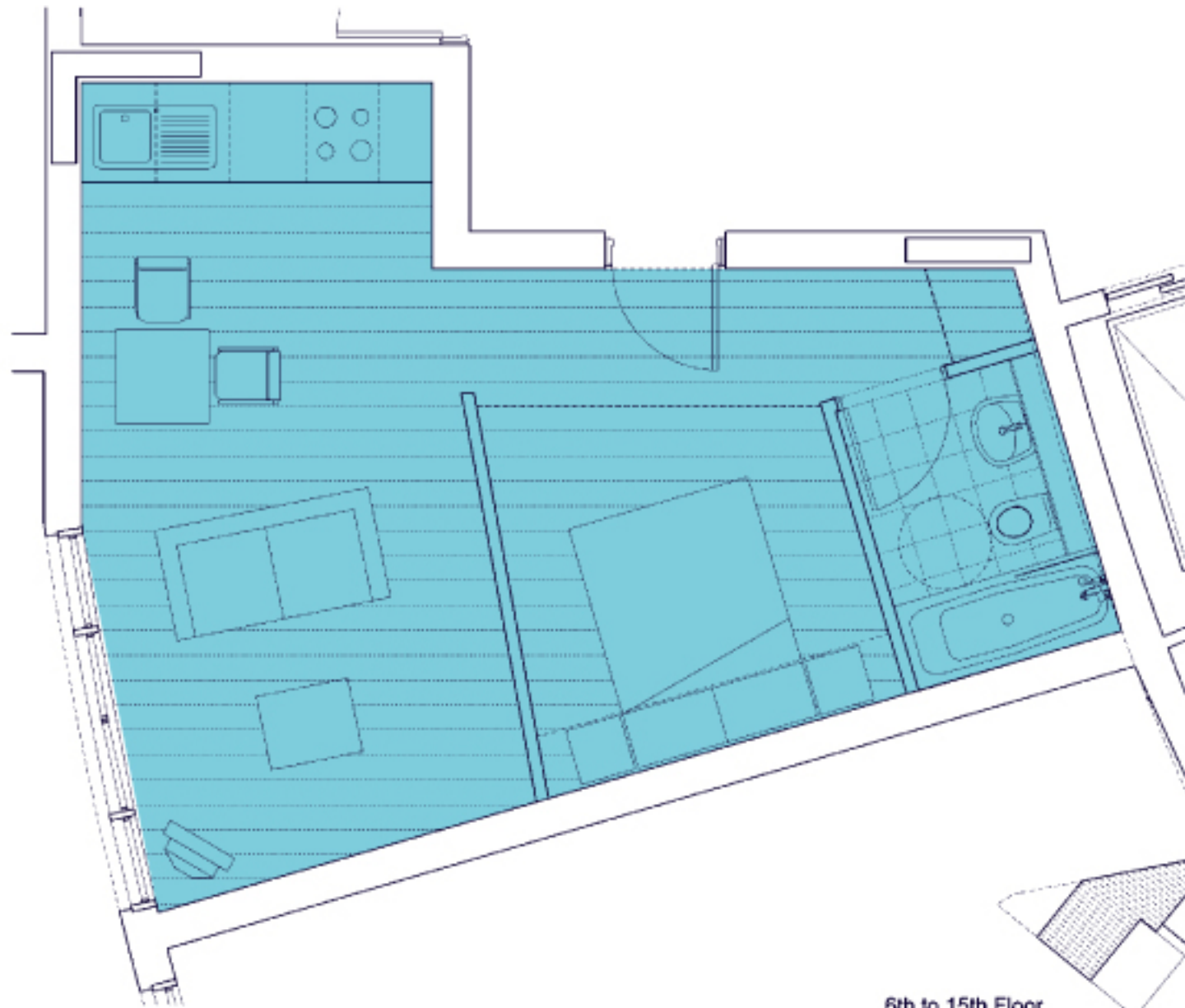

6th to 15th Floor

1st Floor

2nd Floor

3rd to 4th Floor

5th Floor

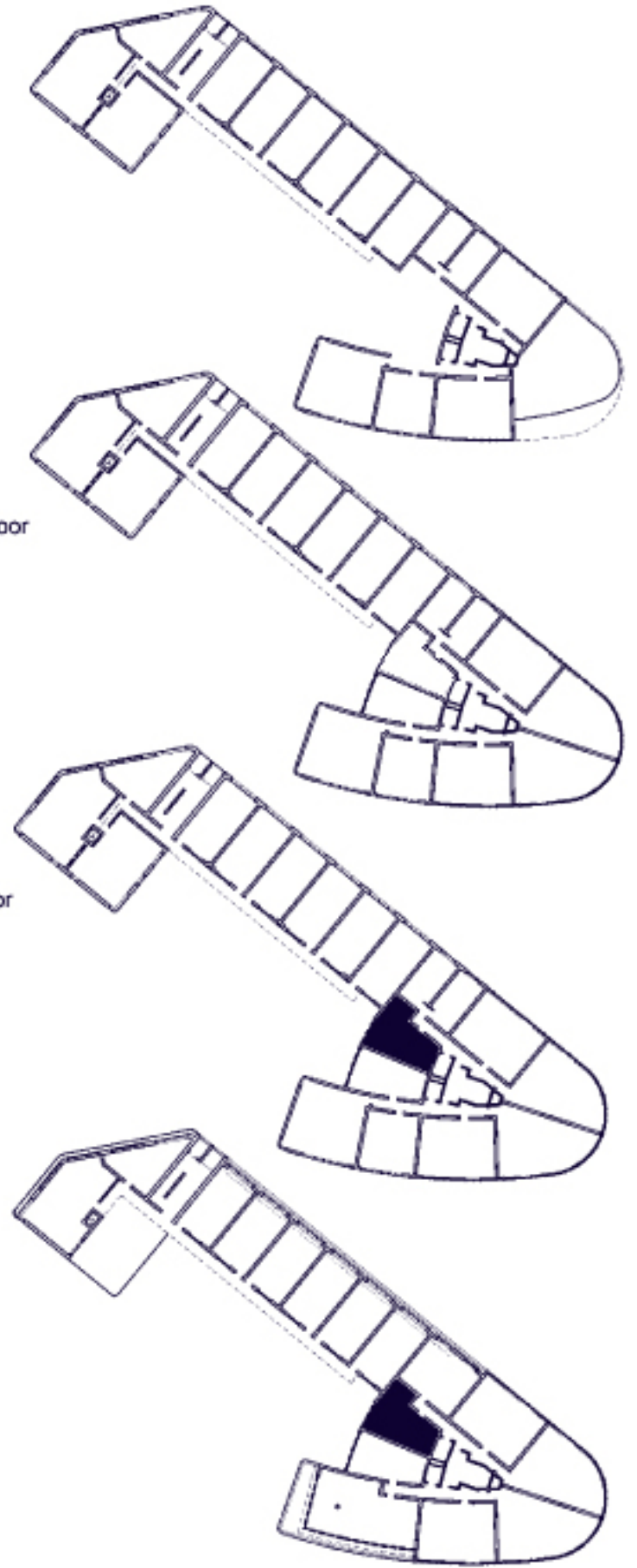

01

1 BF Studio, Type N  
Total = 3

36.5 m<sup>2</sup>  
1:50



3rd Floor B309  
4th Floor B409  
5th Floor B509

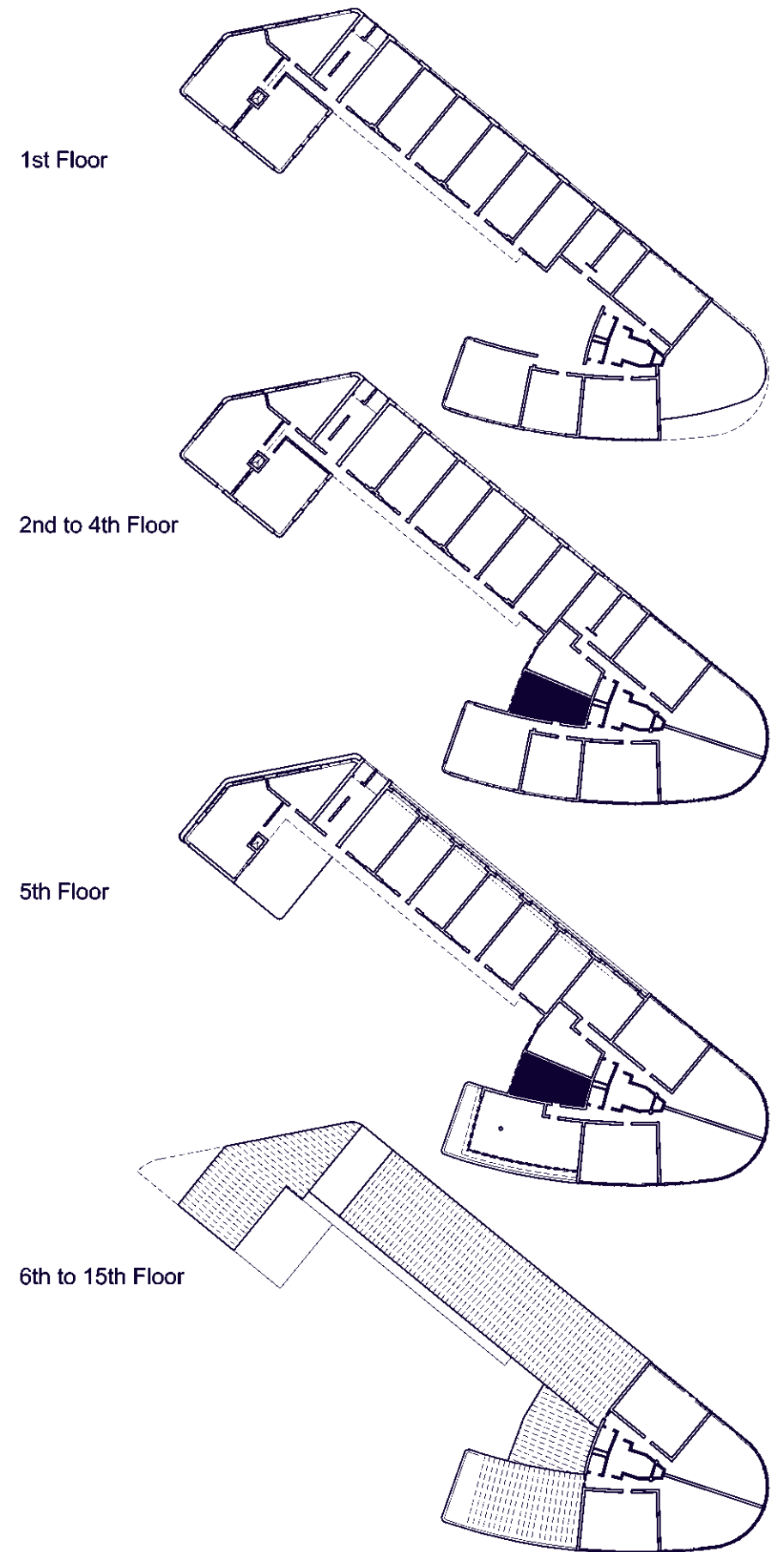

01

1 BF Studio, Type Q  
Total = 3

34.5 m<sup>2</sup>  
1:50





1st Floor B101  
2nd Floor B201  
3rd Floor B301  
4th Floor B401



01

2 BF Bedroom, Type L  
Total = 4

67 m<sup>2</sup>  
1:50

1st Floor

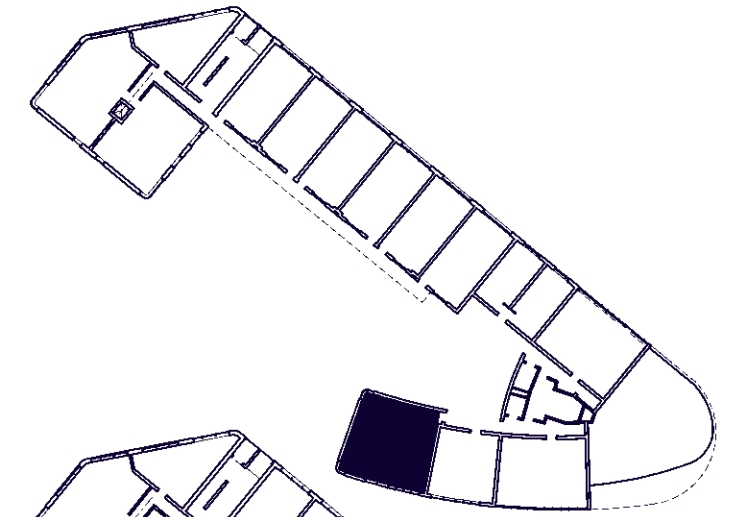

2nd to 4th Floor

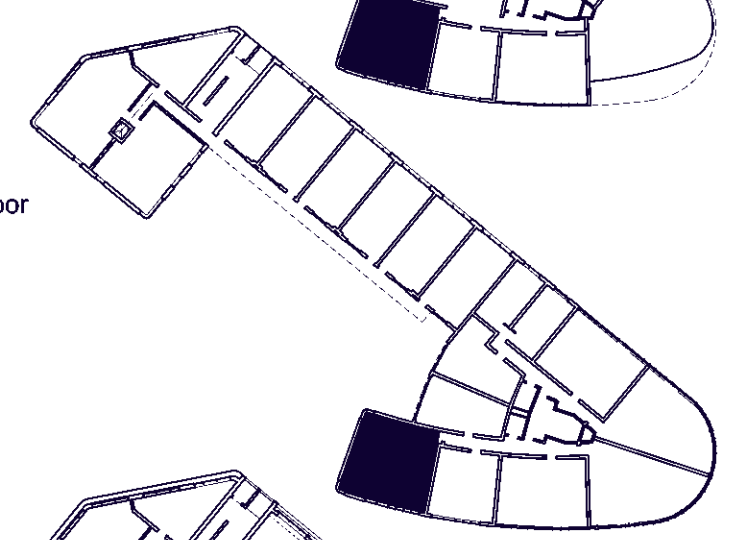

5th Floor

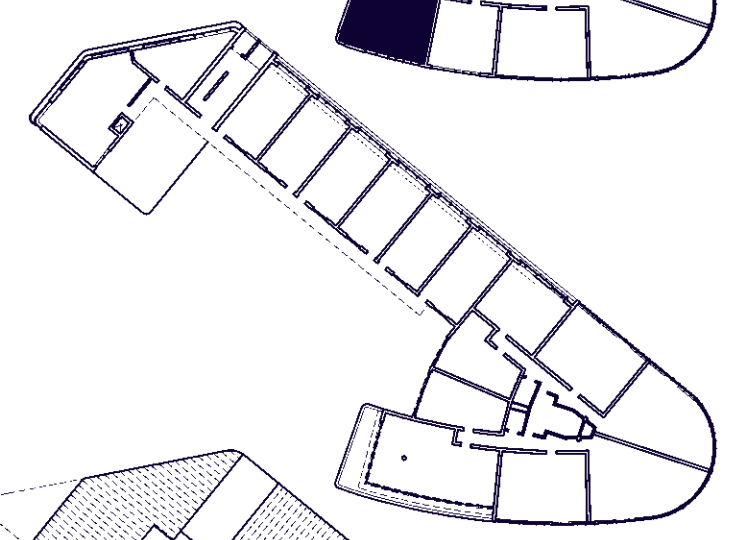

6th to 15th Floor

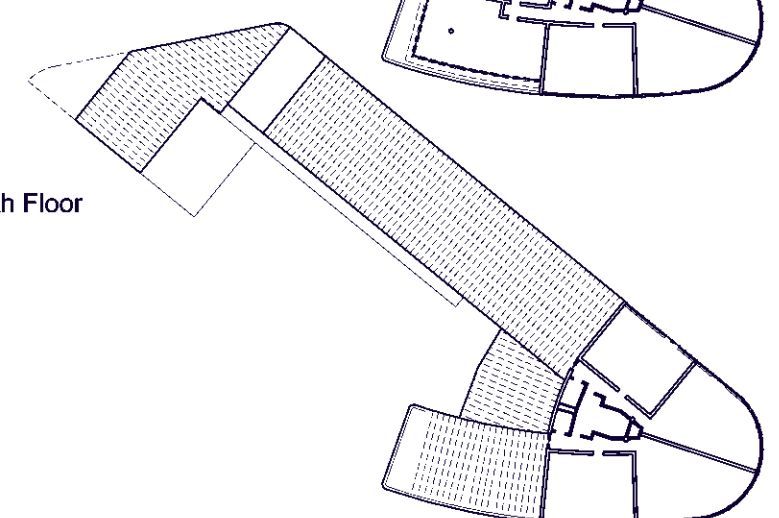





- 3rd Floor B305
- 4th Floor B405
- 5th Floor B505
- 6th Floor B605
- 7th Floor B705
- 8th Floor B805
- 9th Floor B905
- 10th Floor B1005
- 11th Floor B1105
- 12th Floor B1205
- 13th Floor B1305
- 14th Floor B1405
- 15th Floor B1505

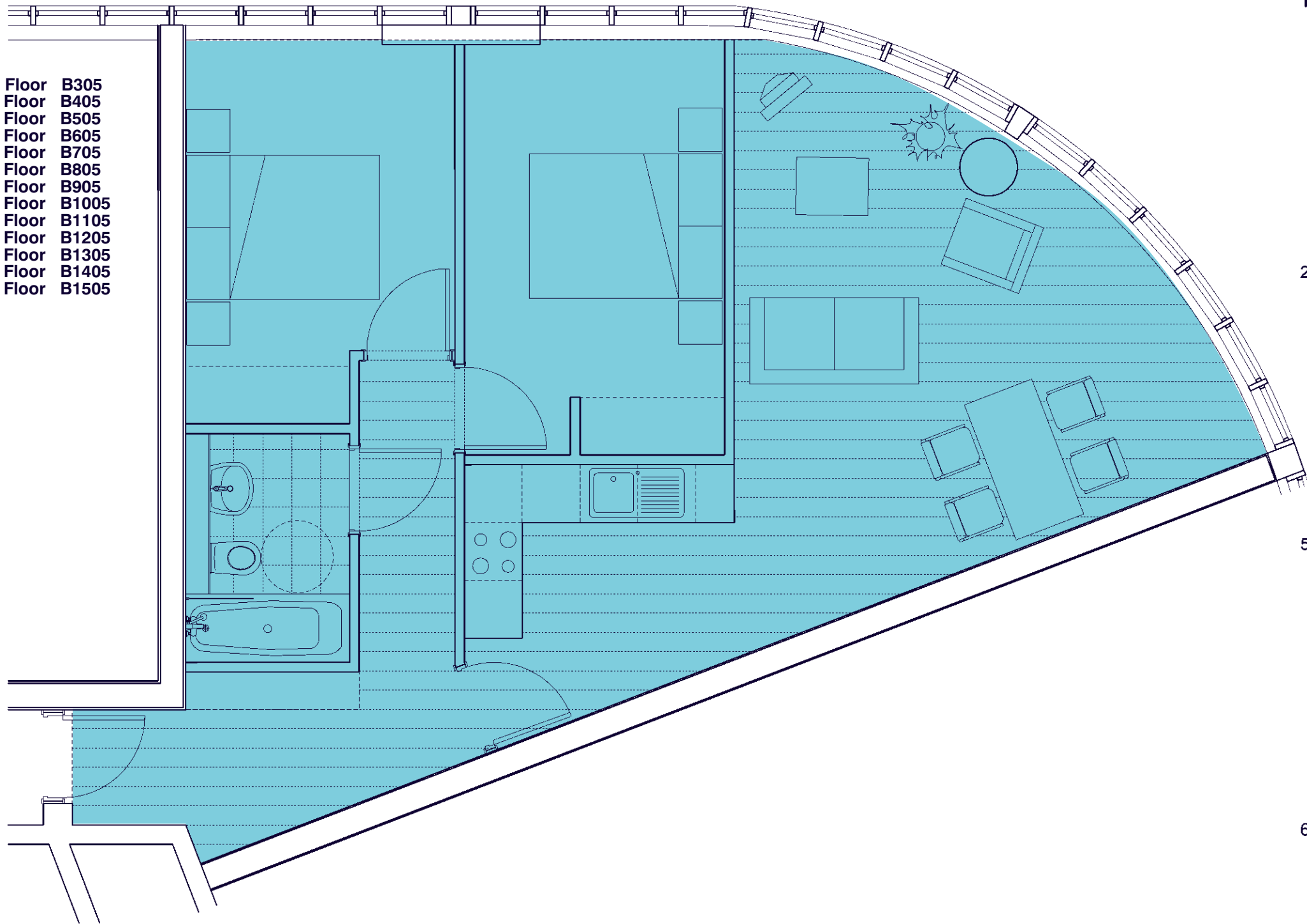

1st Floor

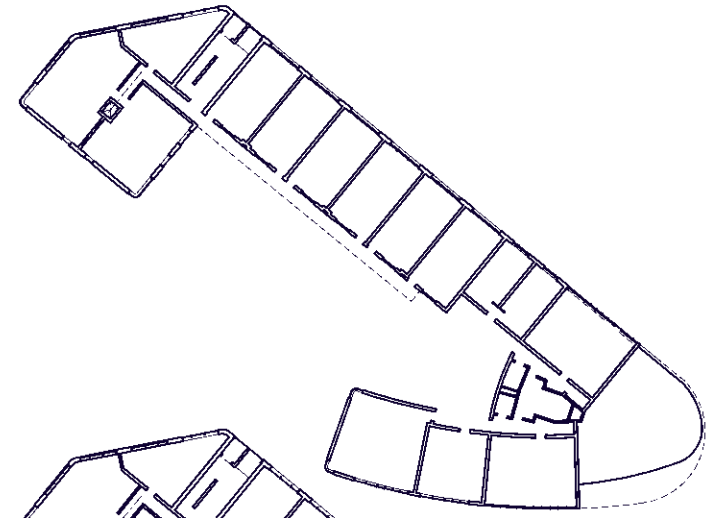

2nd to 4th Floor

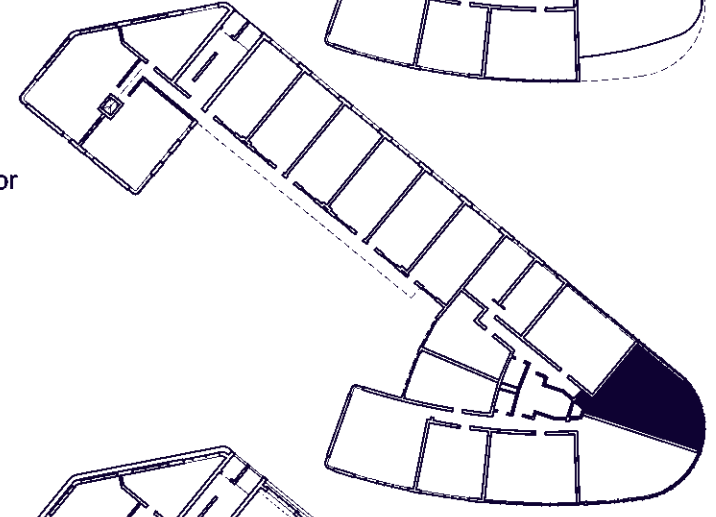

5th Floor

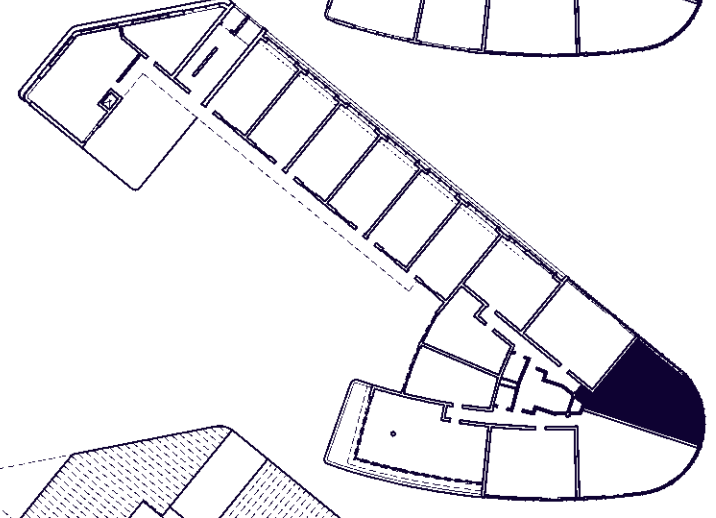

6th to 15th Floor

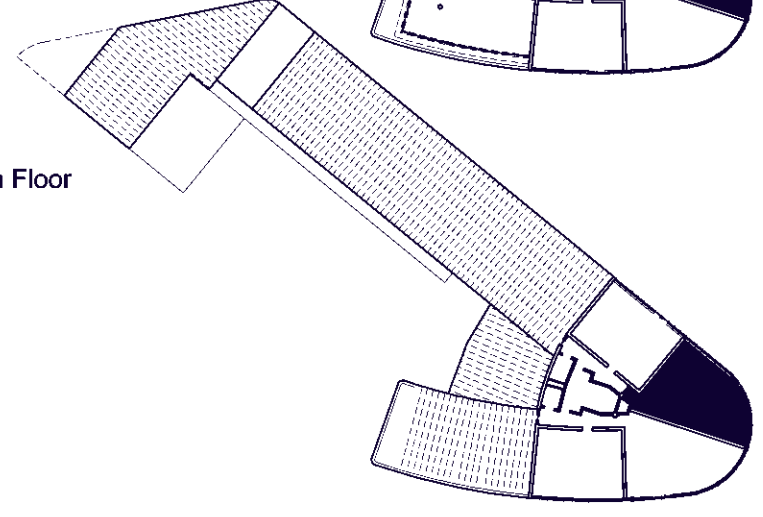

01

2 BF Bedroom, Type G  
Total = 13

68.5 m2  
1:50

14

1st Floor B102  
2nd Floor B202  
3rd Floor B302  
4th Floor B402



1st Floor

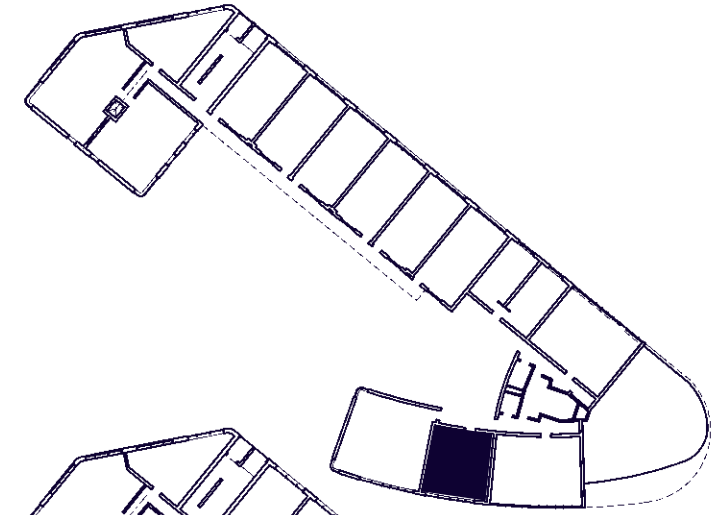

2nd to 4th Floor

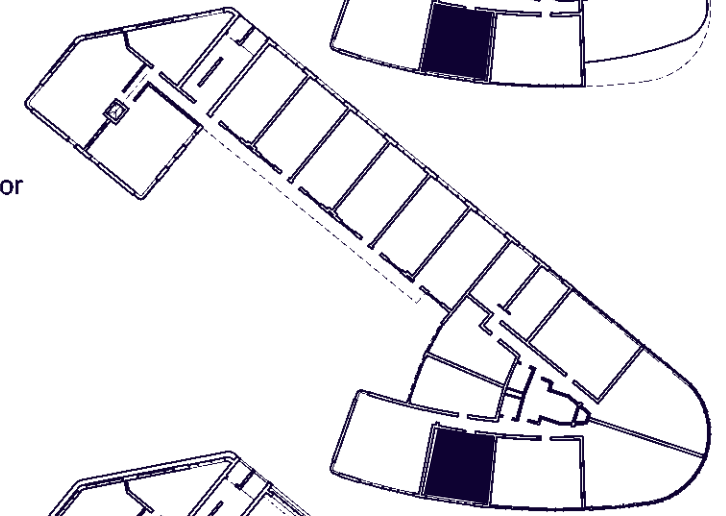

5th Floor

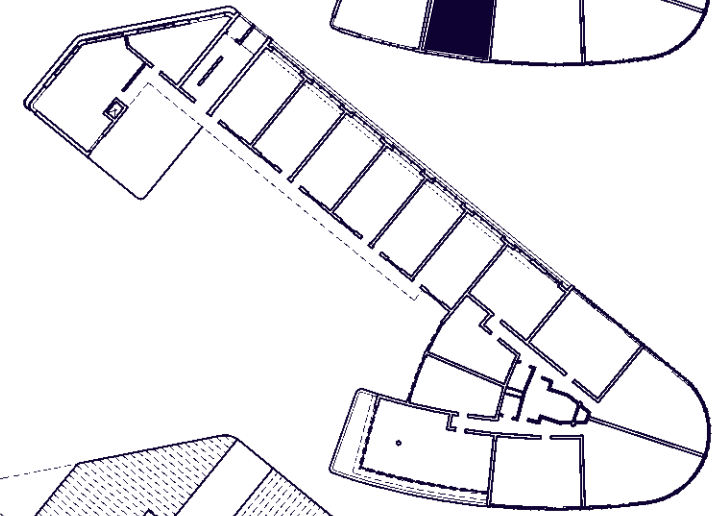

6th to 15th Floor

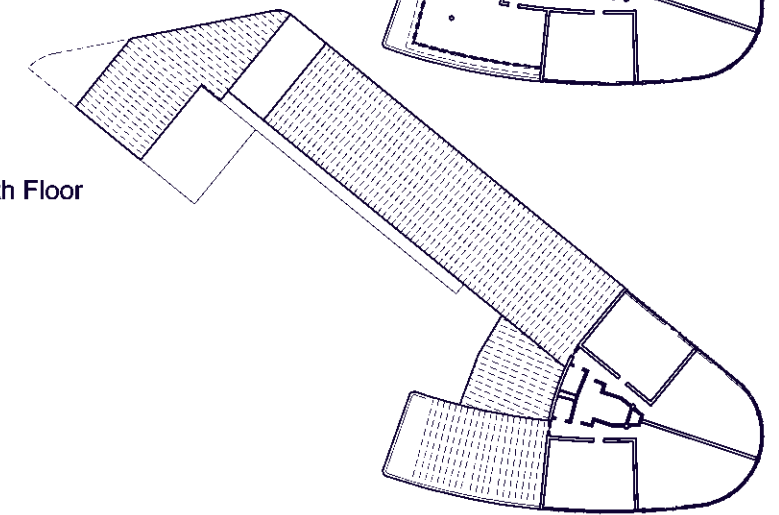

01

1 BF Bedroom, Type K  
Total = 4

41 m<sup>2</sup>  
1:50



- 2nd Floor B203
- 3rd Floor B303
- 4th Floor B403
- 5th Floor B503
- 6th Floor B603
- 7th Floor B703
- 8th Floor B803
- 9th Floor B903
- 10th Floor B1003
- 11th Floor B1103
- 12th Floor B1203
- 13th Floor B1303
- 14th Floor B1403
- 15th Floor B1503



1st Floor

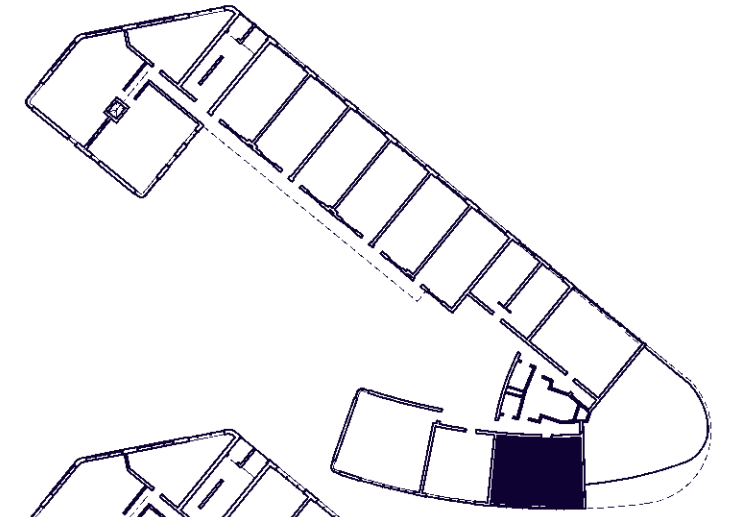

2nd to 4th Floor

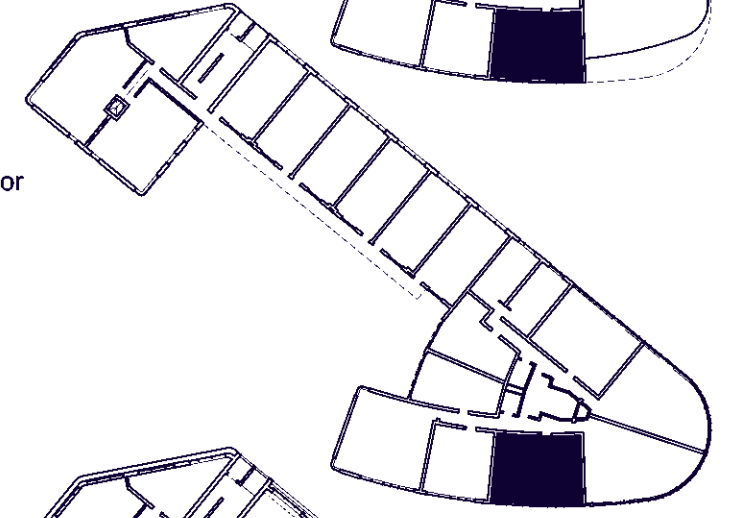

5th Floor

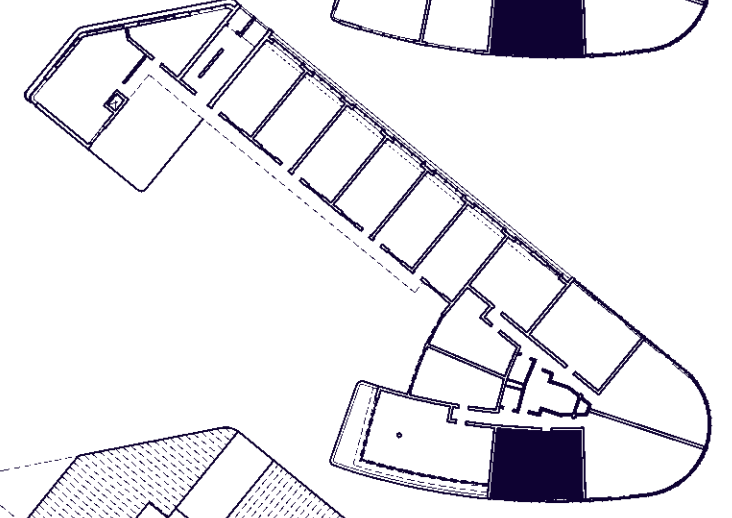

6th to 15th Floor

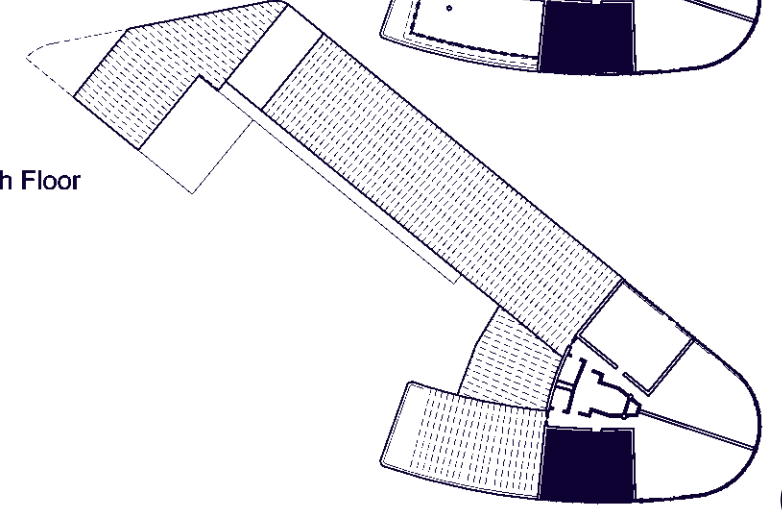

01

2 BF Bedroom, Type J  
Total = 14

57 m2  
1:50





- 3rd Floor B304
- 4th Floor B404
- 5th Floor B504
- 6th Floor B604
- 7th Floor B704
- 8th Floor B804
- 9th Floor B904
- 10th Floor B1004
- 11th Floor B1104
- 12th Floor B1204
- 13th Floor B1304
- 14th Floor B1404
- 15th Floor B1504



01

2 BF Bedroom, Type H  
Total =13

69 m<sup>2</sup>  
1:50

1st Floor

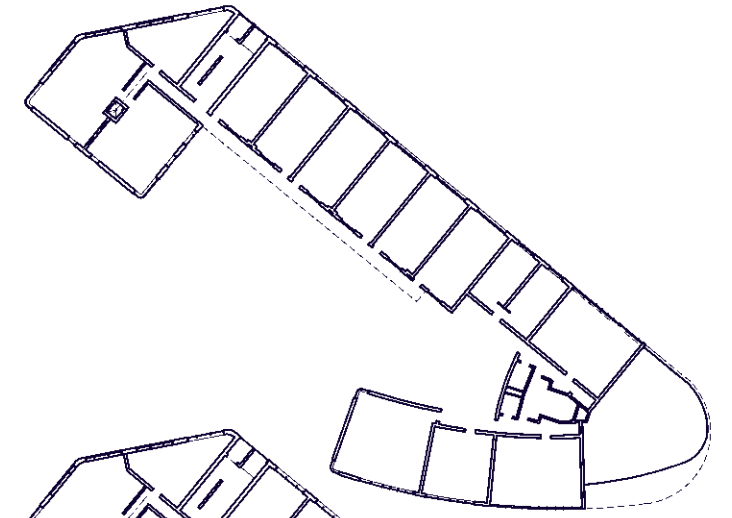

2nd to 4th Floor

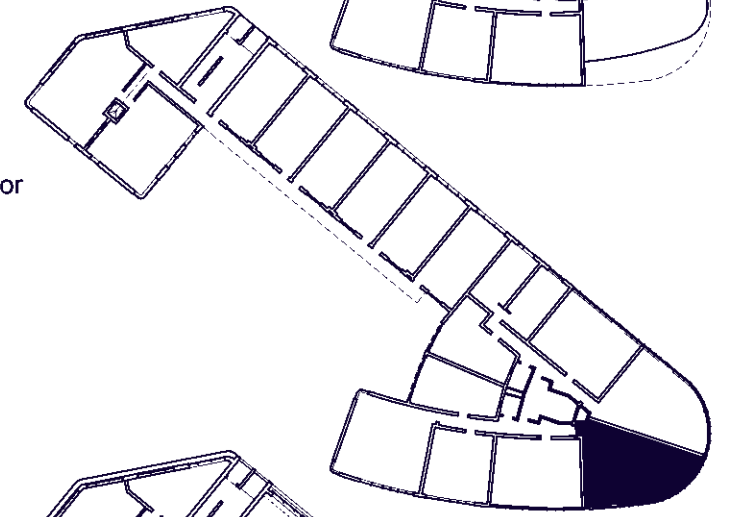

5th Floor

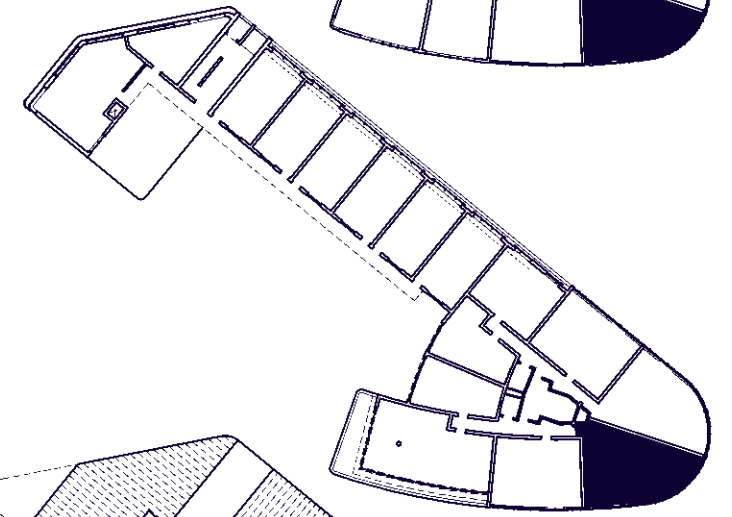

6th to 15th Floor

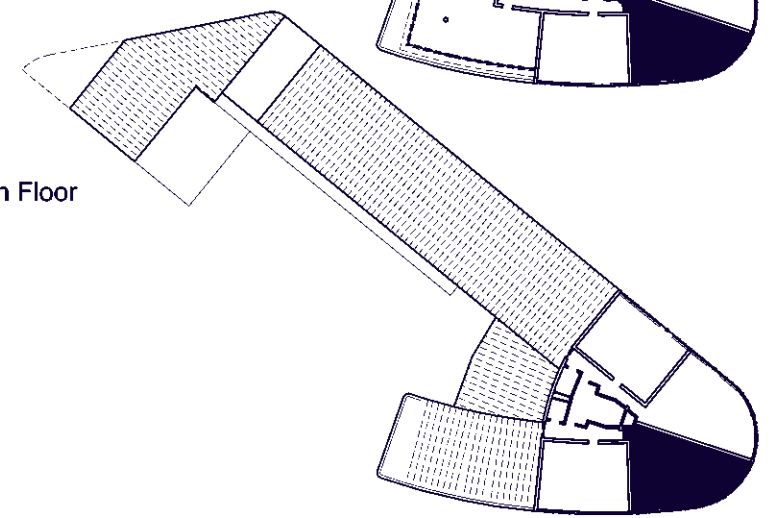





- 1st Floor C101
- 1st Floor C102
- 1st Floor C103
- 1st Floor C104
- 1st Floor C105
- 1st Floor C106
- 2nd Floor C201
- 2nd Floor C202
- 2nd Floor C203
- 2nd Floor C204
- 2nd Floor C205
- 2nd Floor C206
- 3rd Floor C301
- 3rd Floor C302
- 3rd Floor C303
- 3rd Floor C304
- 3rd Floor C305
- 3rd Floor C306
- 4th Floor C401
- 4th Floor C402
- 4th Floor C403
- 4th Floor C404
- 4th Floor C405
- 4th Floor C406

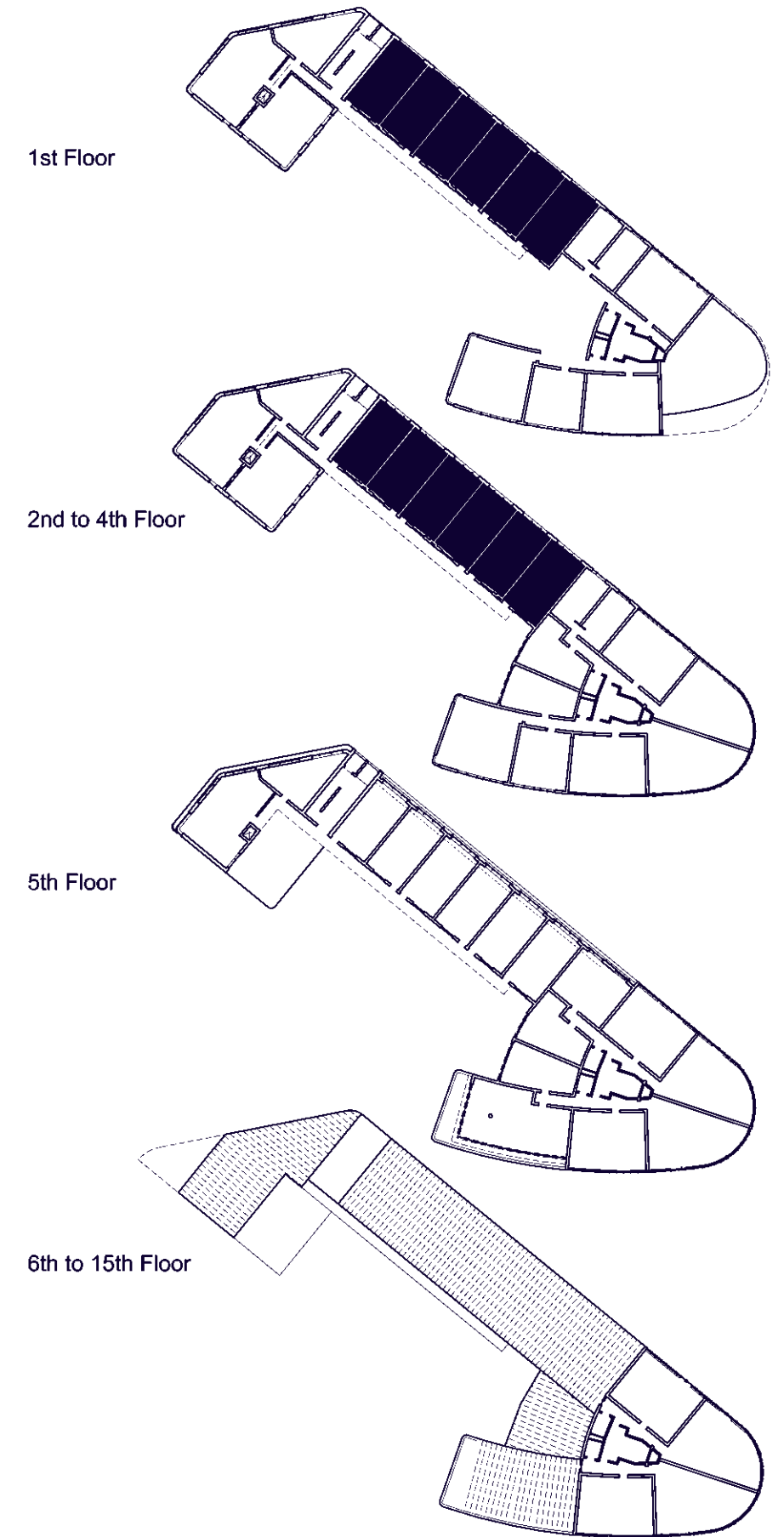
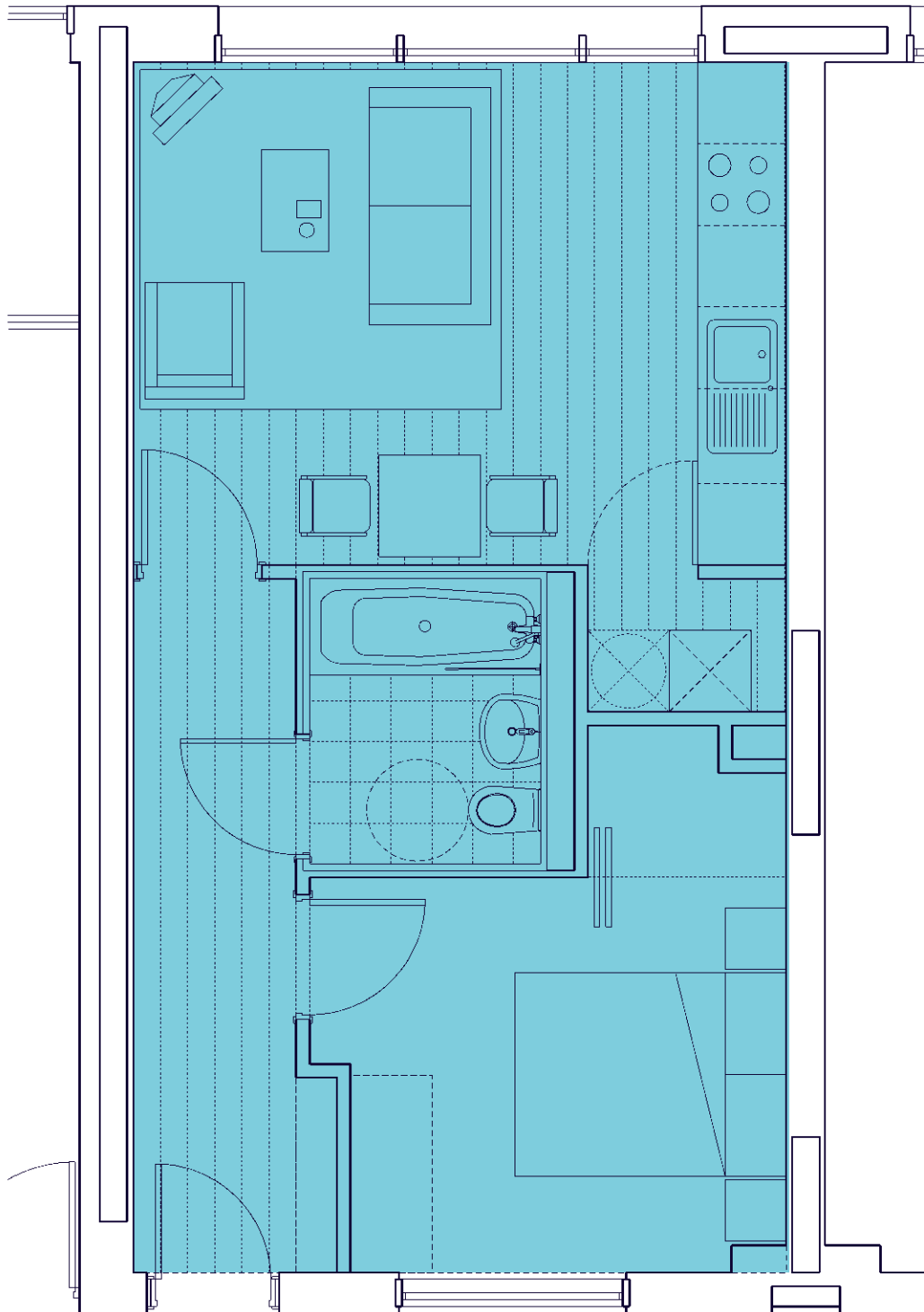

01

1 BF Bedroom, Type D  
Total =24

43 m<sup>2</sup>  
1:50



Royal  
Exchange  
Buildings

Refer to 385 AL(0)121  
for detailed plans

Refer to 385 AL(0)121  
for detailed plans

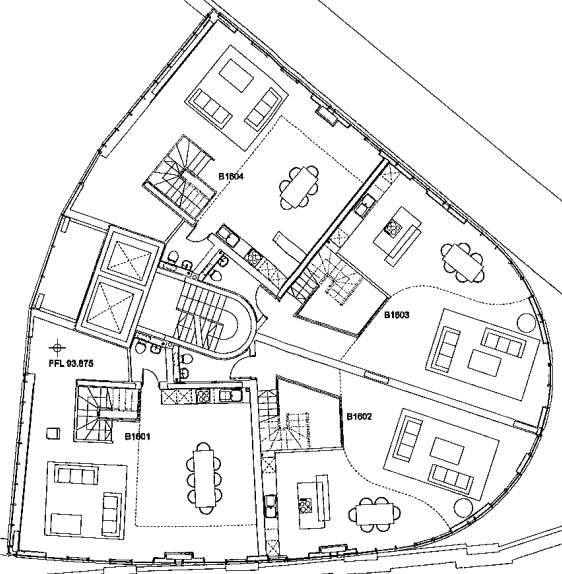



Royal  
Exchange  
Buildings

Refer to 385 AL(0)121  
for detailed plans

Refer to 385 AL(0)121  
for detailed plans

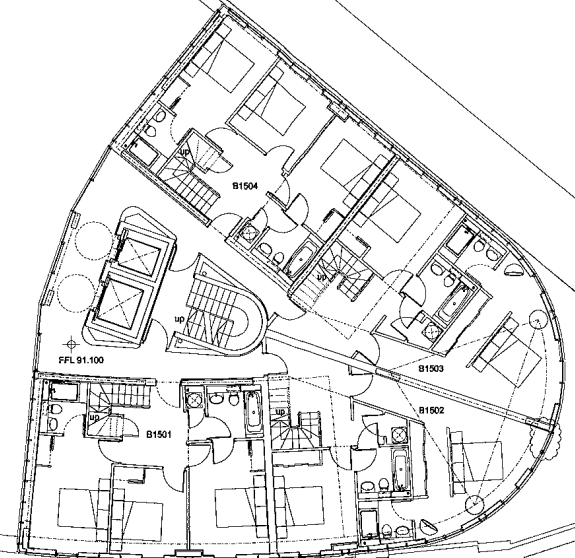

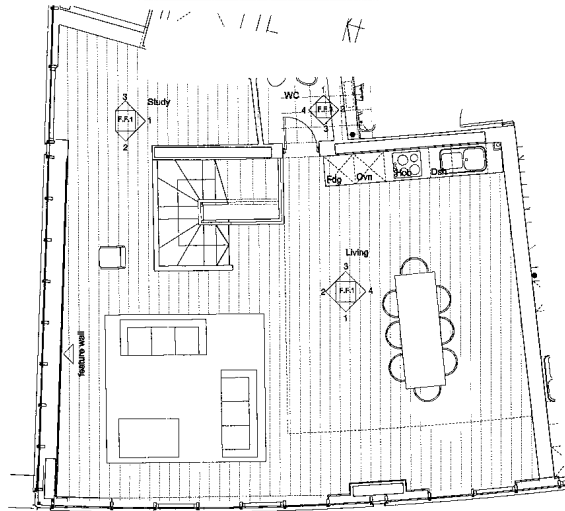

01 3 Bedroom, Type X  
Total = 1

61 m<sup>2</sup>  
1:50

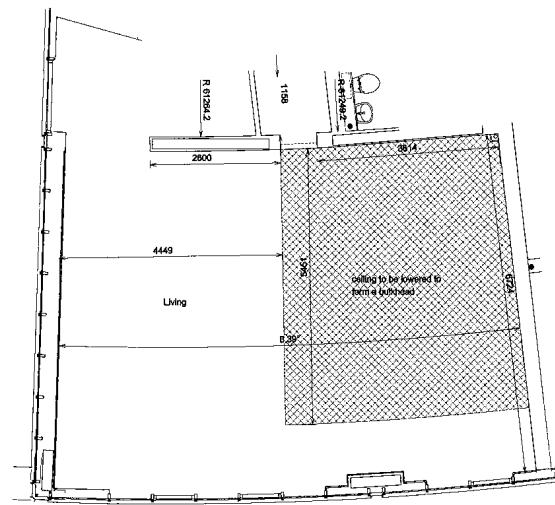

02 Reflective Ceiling Plan

1:50

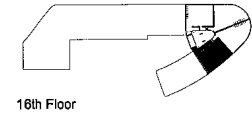

16th Floor

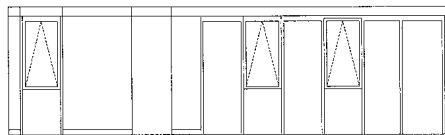

Elevation 1- Living

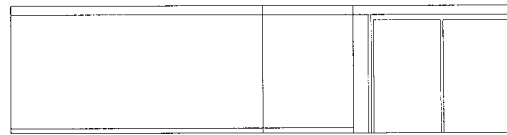

Elevation 2- Living

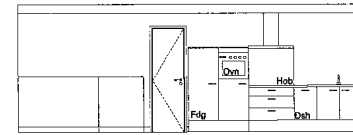

Elevation 3- Living



Elevation 4- Living



Elevation 1- Study



Elevation 2- Study



Elevation 3- Study

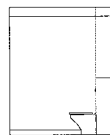

Elevation 1- WC

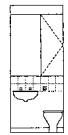

Elevation 2- WC

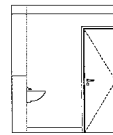

Elevation 3- WC



Elevation 4- WC